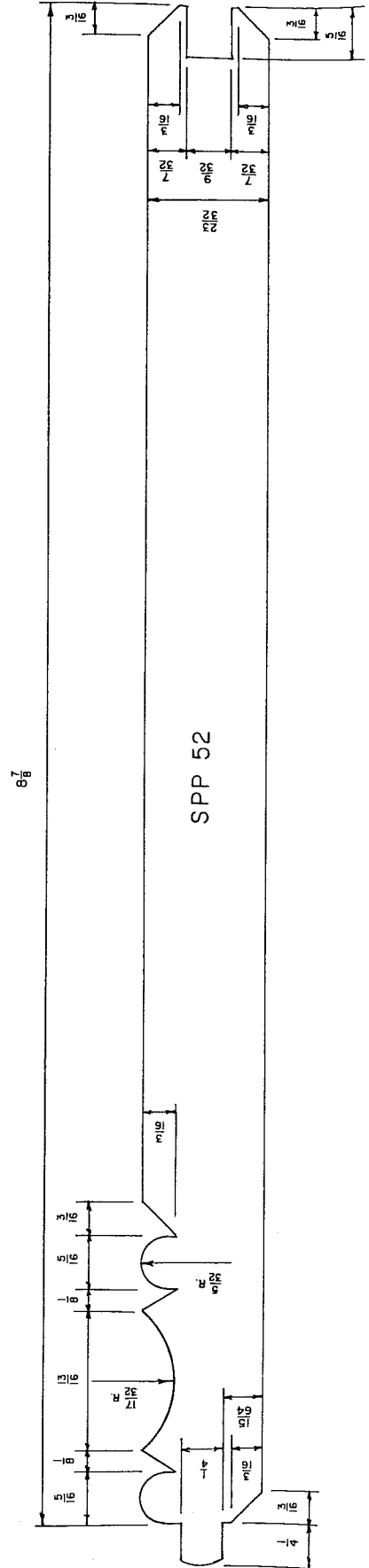
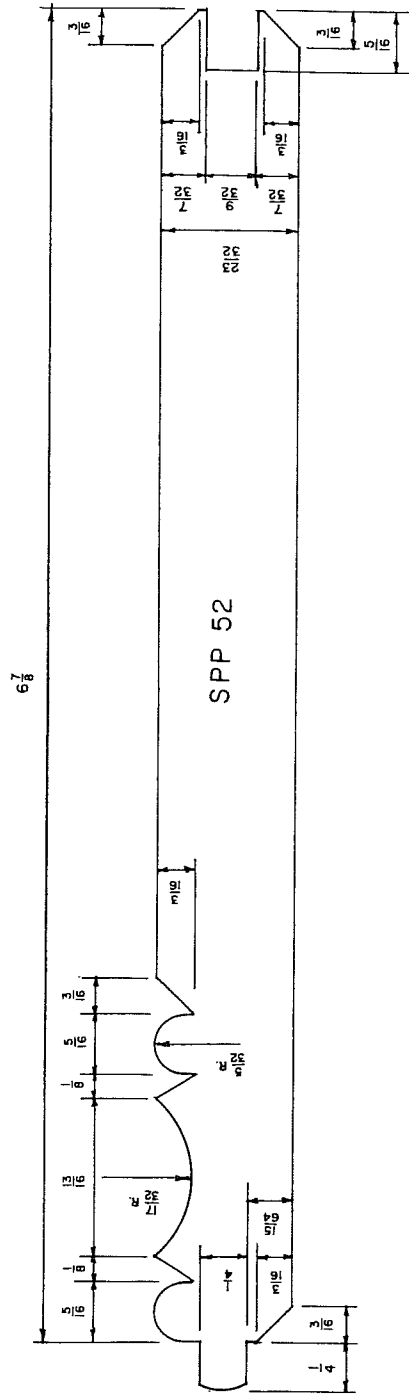
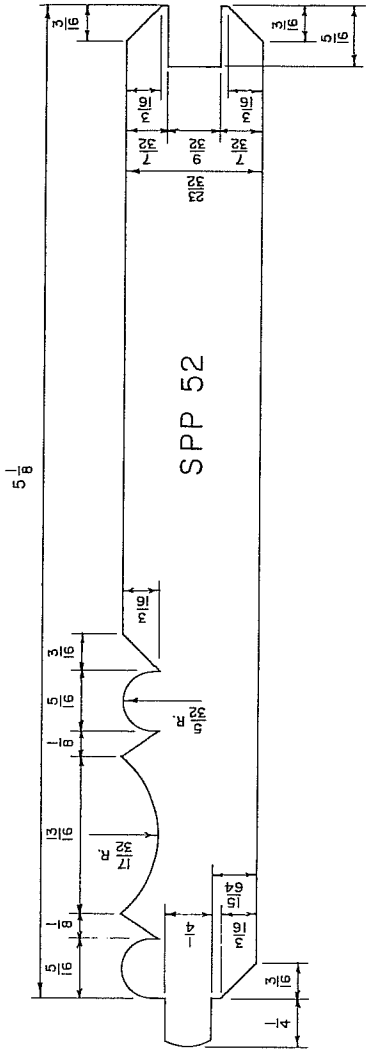

Table of Contents

	PAGE
Standard Patterns of Paneling	1-11
Standard Patterns of Drop Siding	12-30
Standard Pattern of Bevel Siding	31
Standard Pattern of Flooring	32
Standard 1" S2S&CM	32
Standard 1" Shiplap	32
Standard Bead and V Details	33
Standard 2" S2S&CM Flooring or Decking	34
Standard 3" S2S&CM Flooring or Decking	34
Standard 2" S2S&SM Flooring or Decking	35
Standard 2½" S2S&SM Flooring or Decking	35
Standard 3" S2S&SM Flooring or Decking	35
Standard 2" S2S&CG2E (Grooved for Splines)	36
Standard 2" S1S&CG2E (Grooved for Splines)	36
Standard 3" S2S&CG2E (Grooved for Splines)	36
Standard 1" Shiplap	37
Standard 2" S2S&SL (Heavy Shiplap)	37
Special Decking	38
Standard Patterns of Ceiling	39
Standard Pattern of Partition	40
⅝" x 3" OG Batts	40
⅝" x 4" OG Batts	40
Log Cabin Siding	40
Standard Patterns of DT&G Roof Decking	41-44

Copyright 2000 by
SOUTHERN PINE INSPECTION BUREAU, INC.
 4709 Scenic Highway
 Pensacola, Florida 32504
 850/434-2611

STANDARD PATTERNS OF PANELING—Continued
 (Orders should specify pattern numbers.)



STANDARD PATTERNS OF PANELING—Continued
 (Orders should specify pattern numbers.)

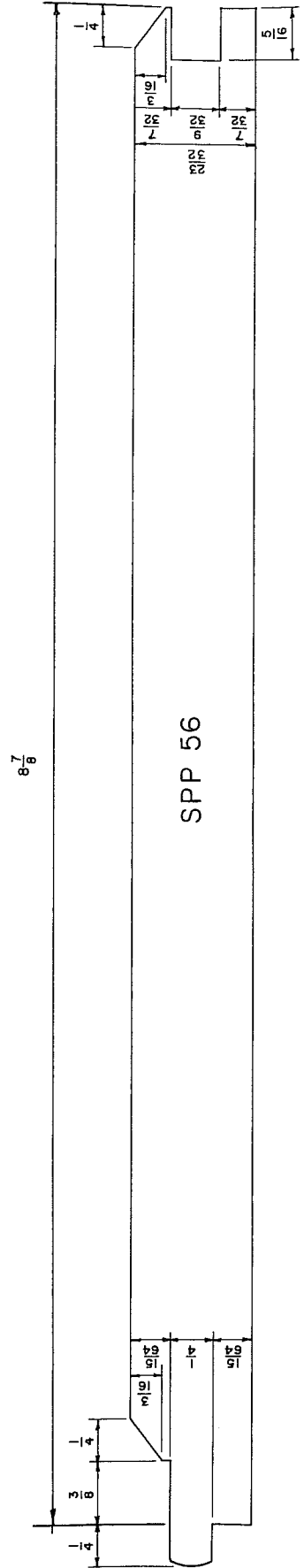
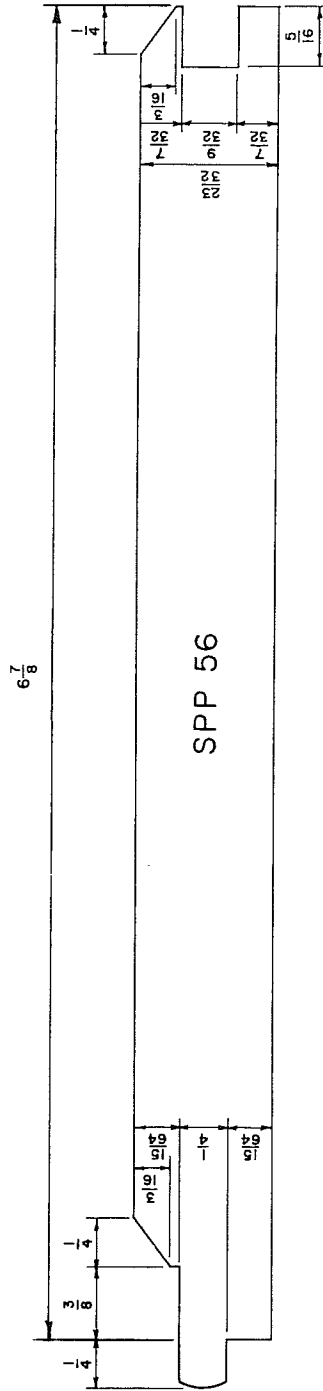
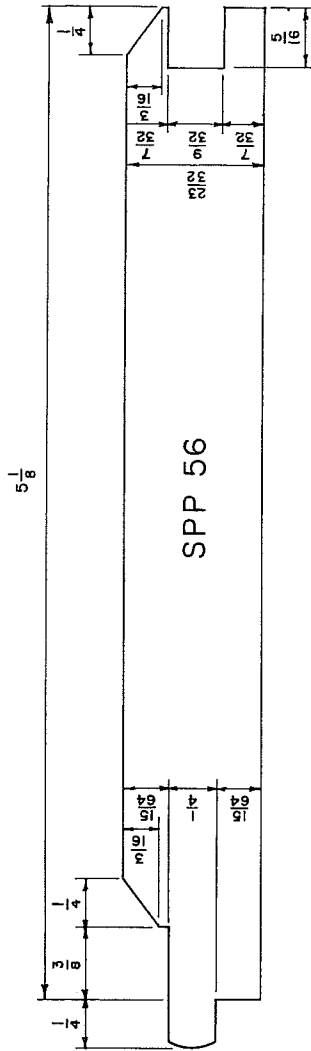

STANDARD PATTERNS OF PANELING—Continued
 (Orders should specify pattern numbers.)

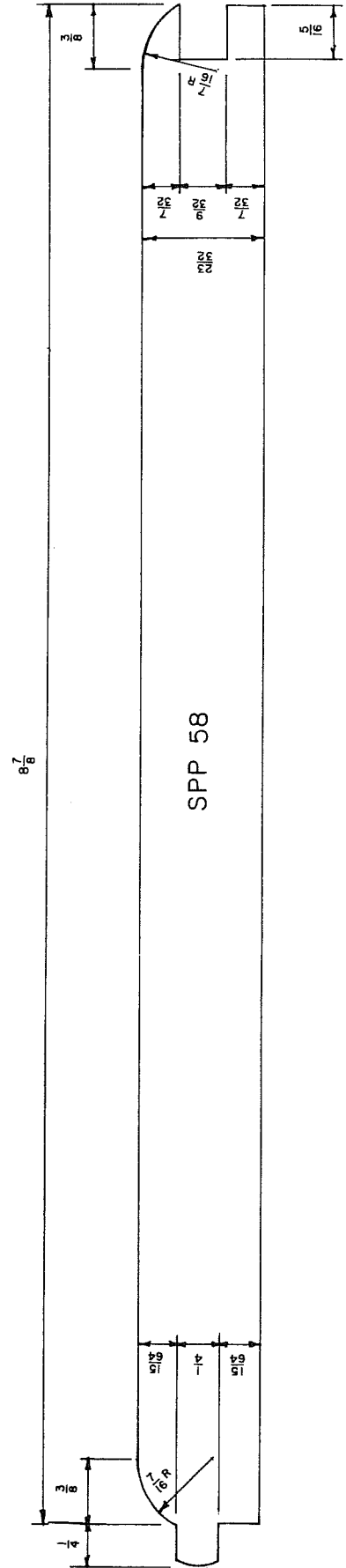
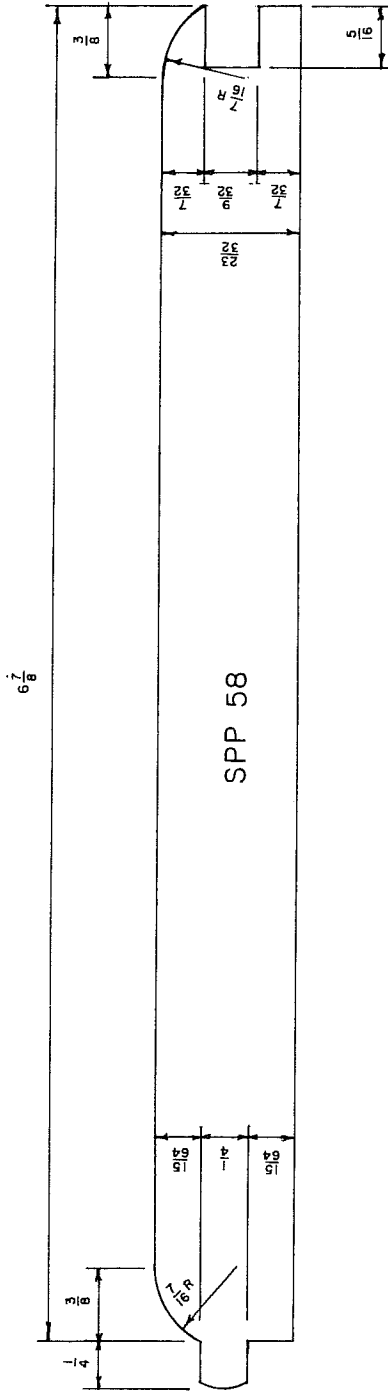
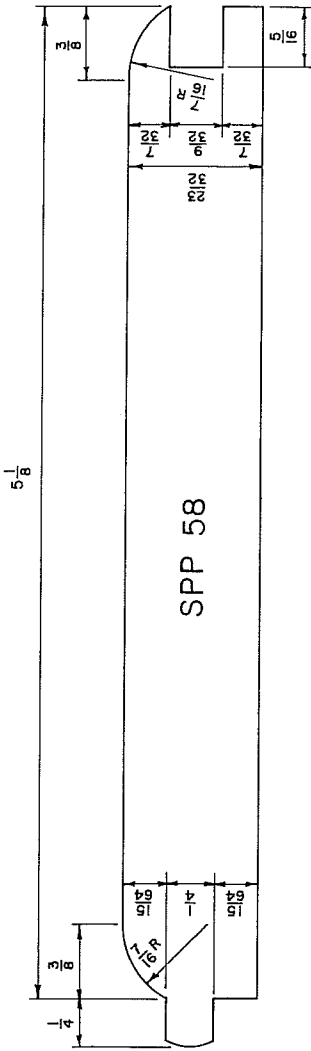

STANDARD PATTERNS OF PANELING—Continued
 (Orders should specify pattern numbers.)

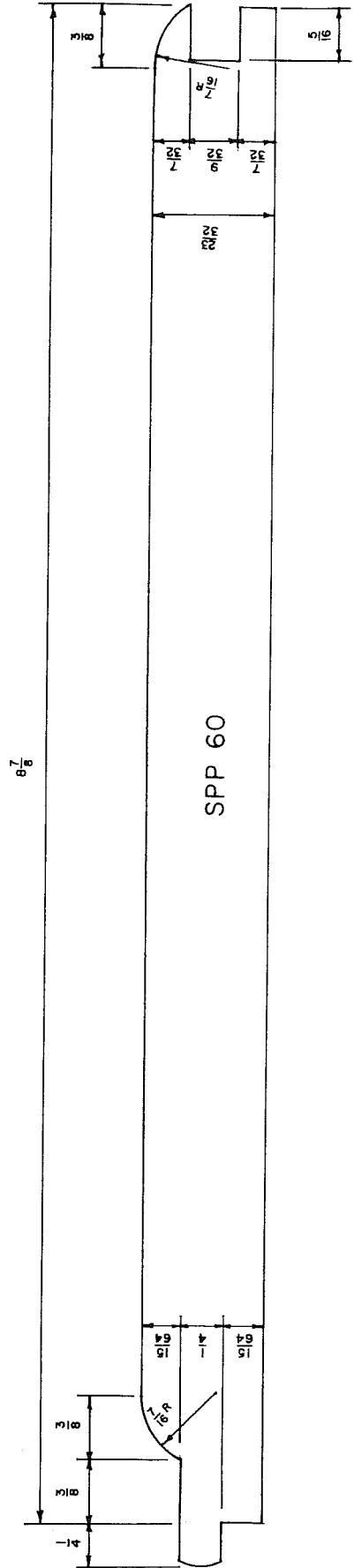
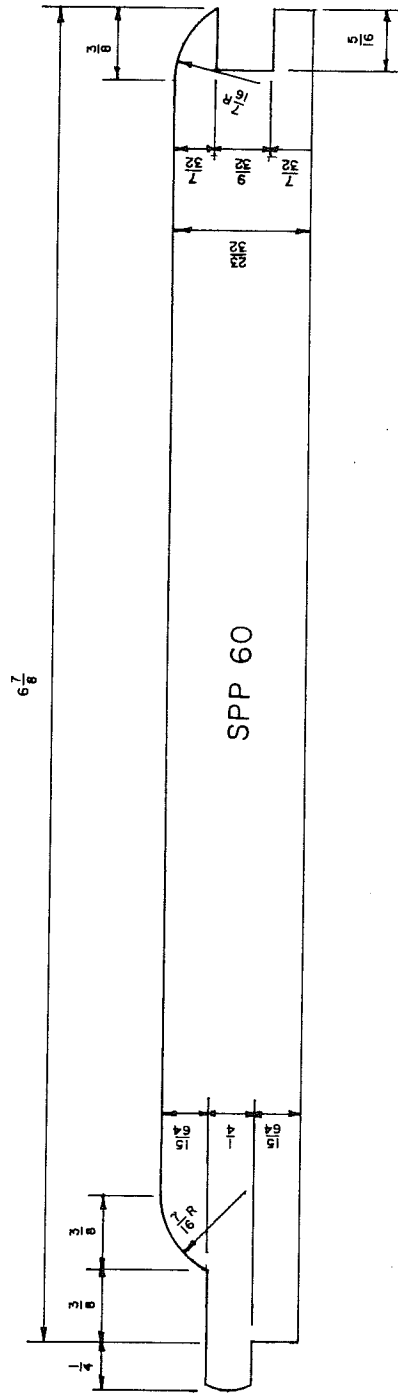
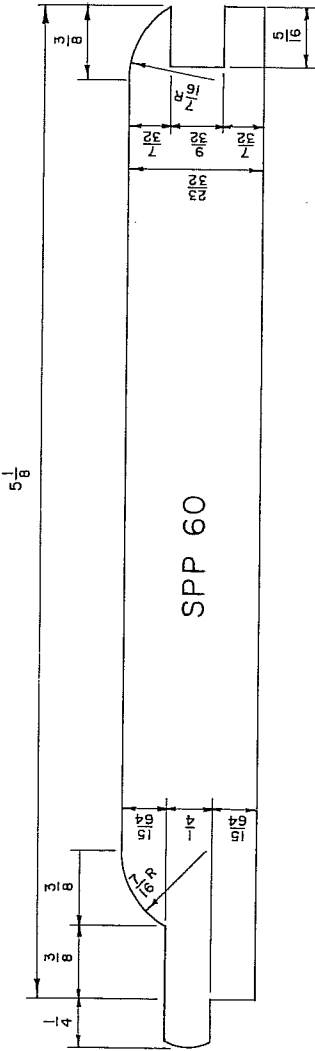

STANDARD PATTERNS OF PANELING—Continued
 (Orders should specify pattern numbers.)

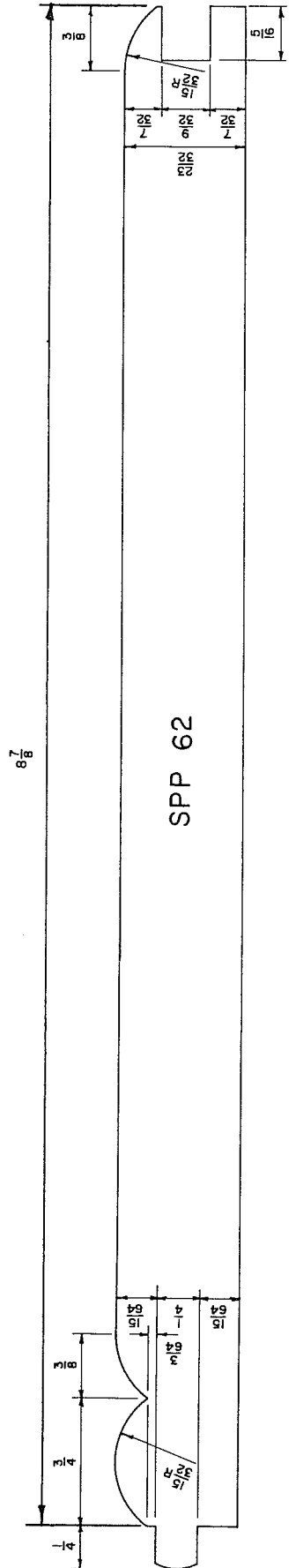
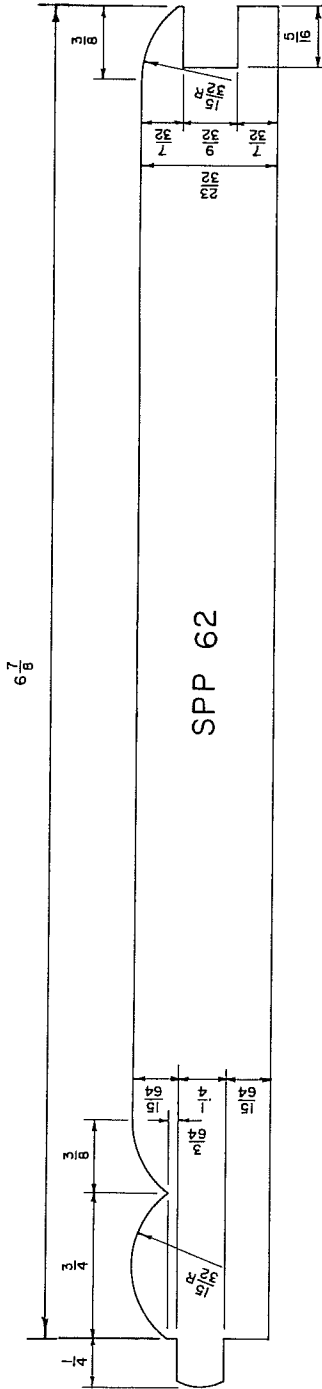
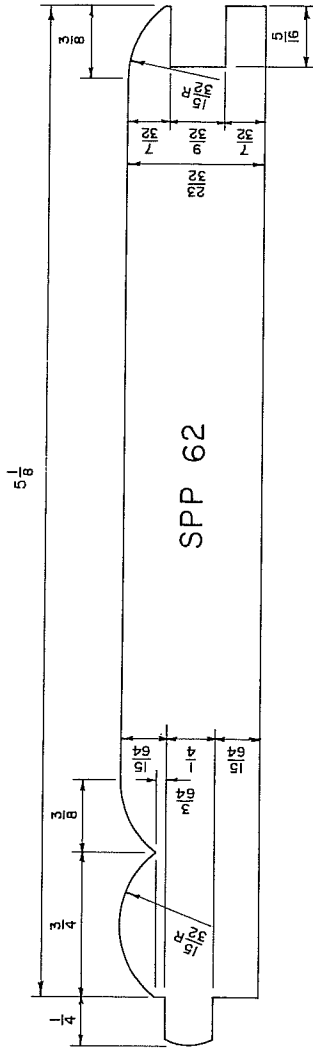

STANDARD PATTERNS OF PANELING—Continued
 (Orders should specify pattern numbers.)

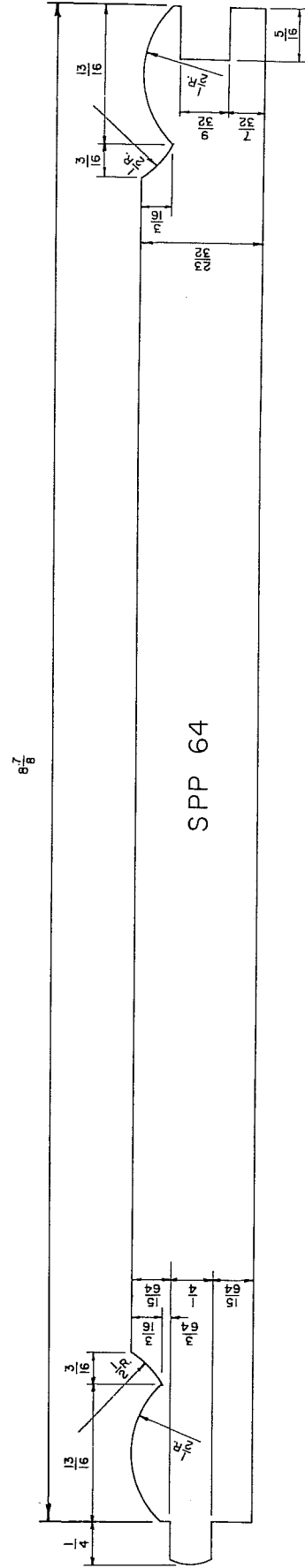
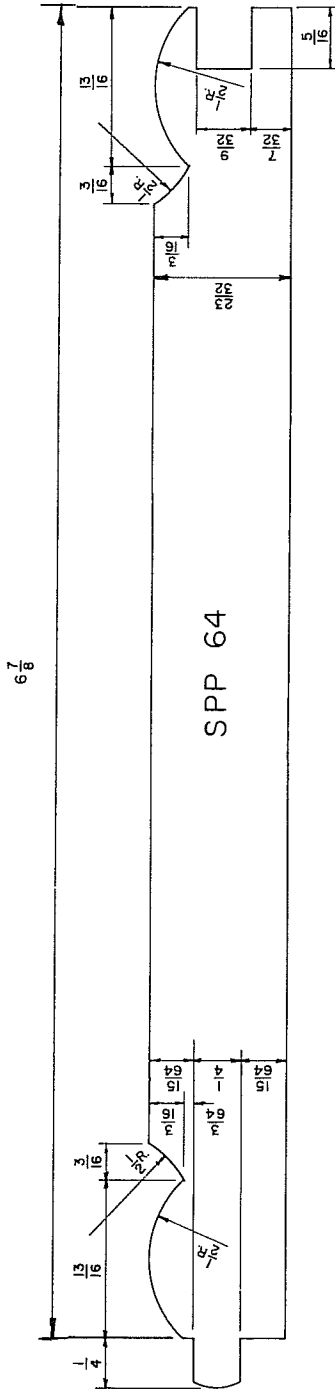
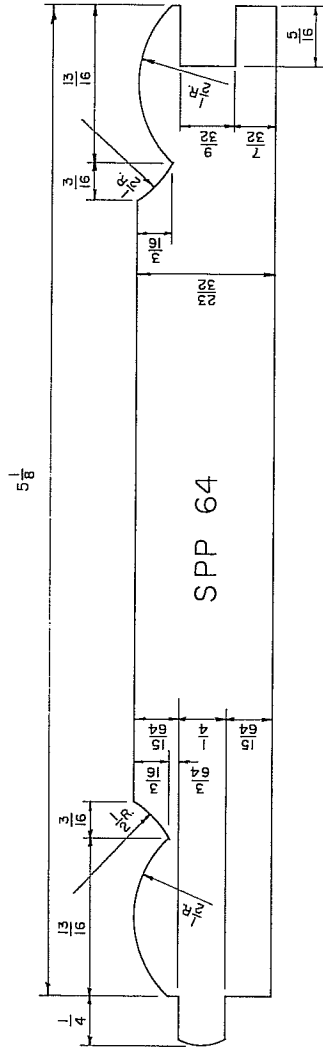

STANDARD PATTERNS OF PANELING—Continued
 (Orders should specify pattern numbers.)

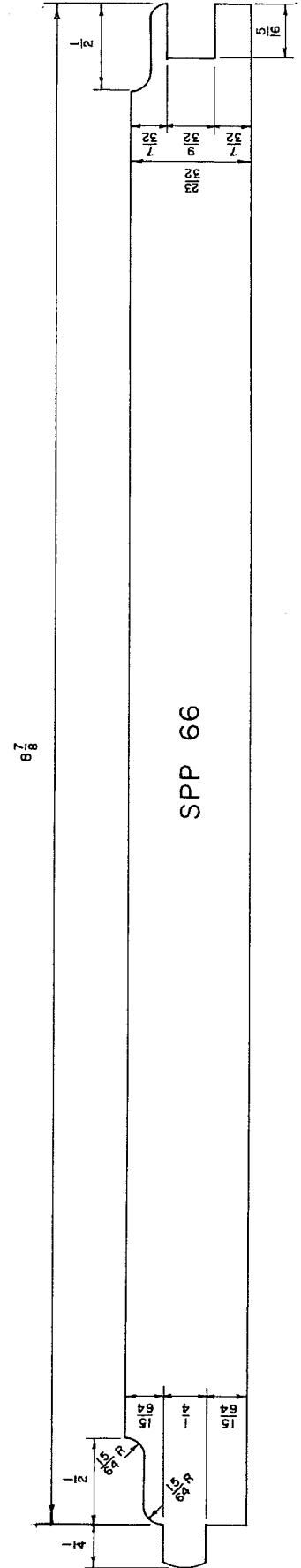
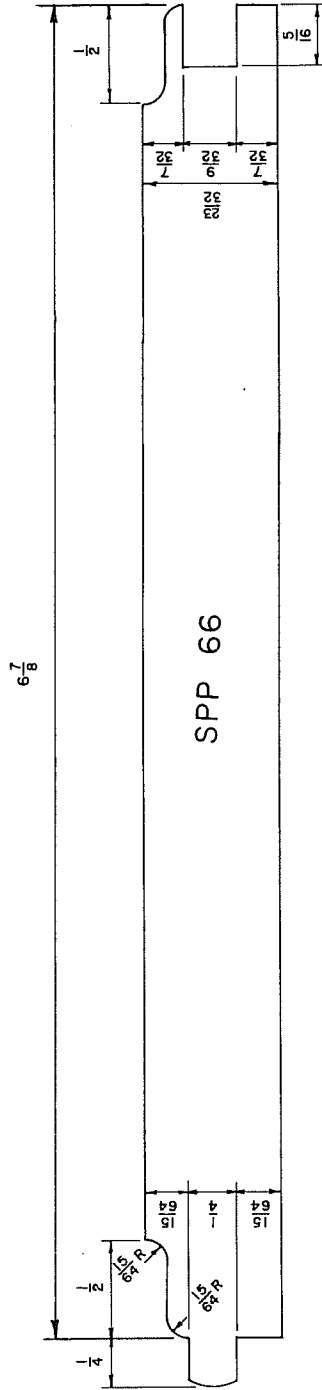
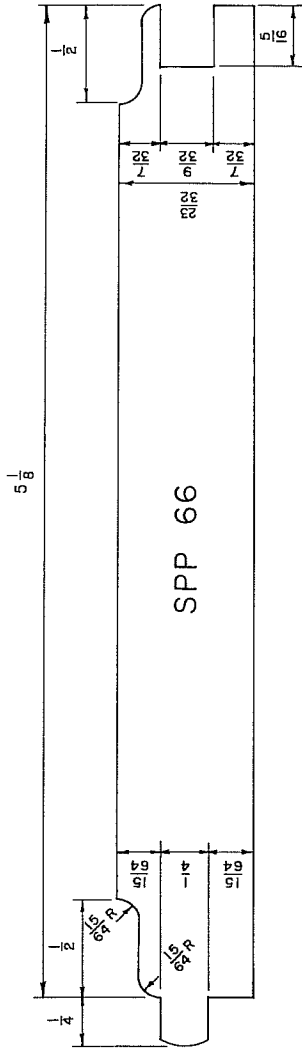

STANDARD PATTERNS OF PANELING—Continued
 (Orders should specify pattern numbers.)

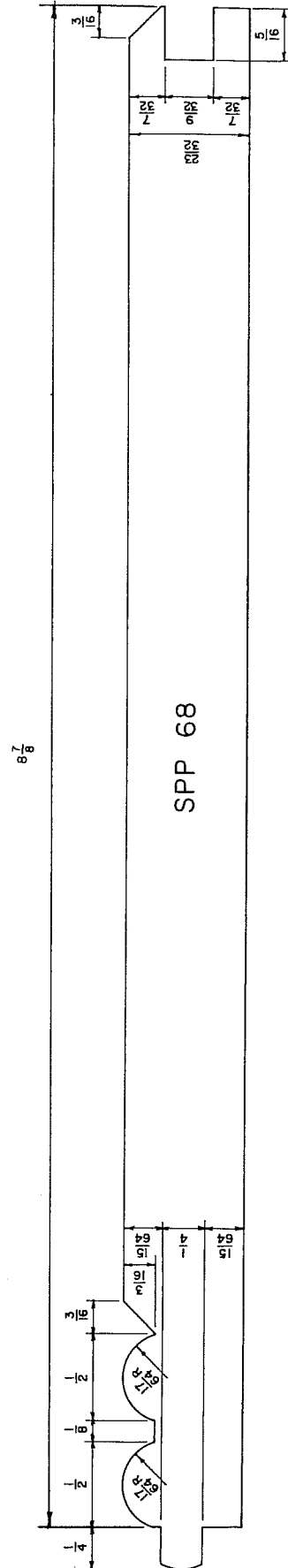
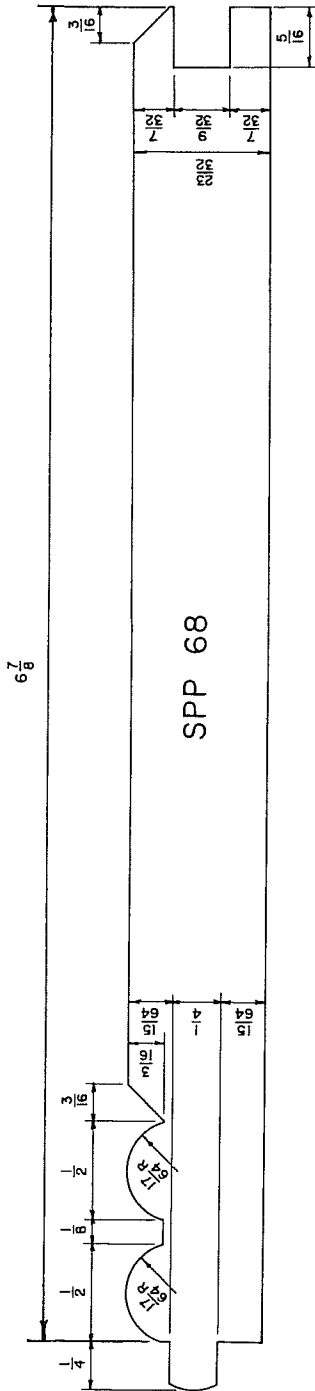
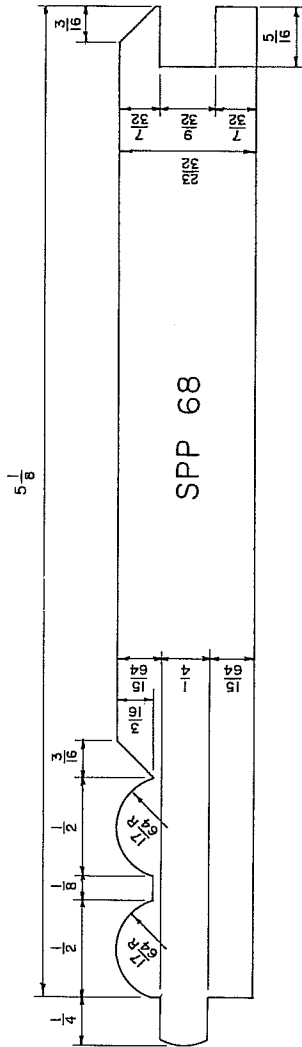

STANDARD PATTERNS OF PANELING—Continued
 (Orders should specify pattern numbers.)

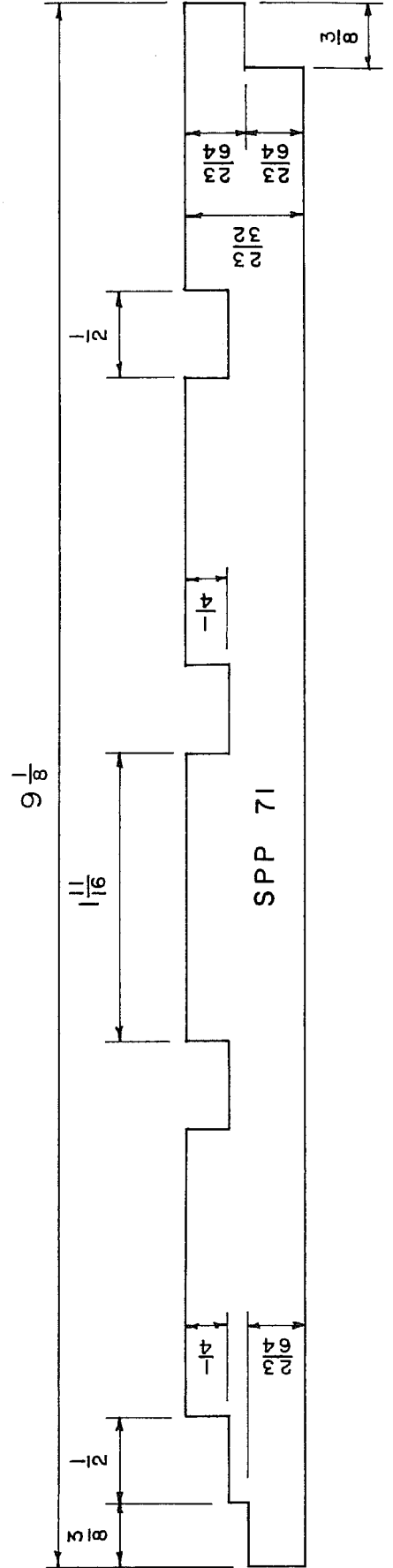
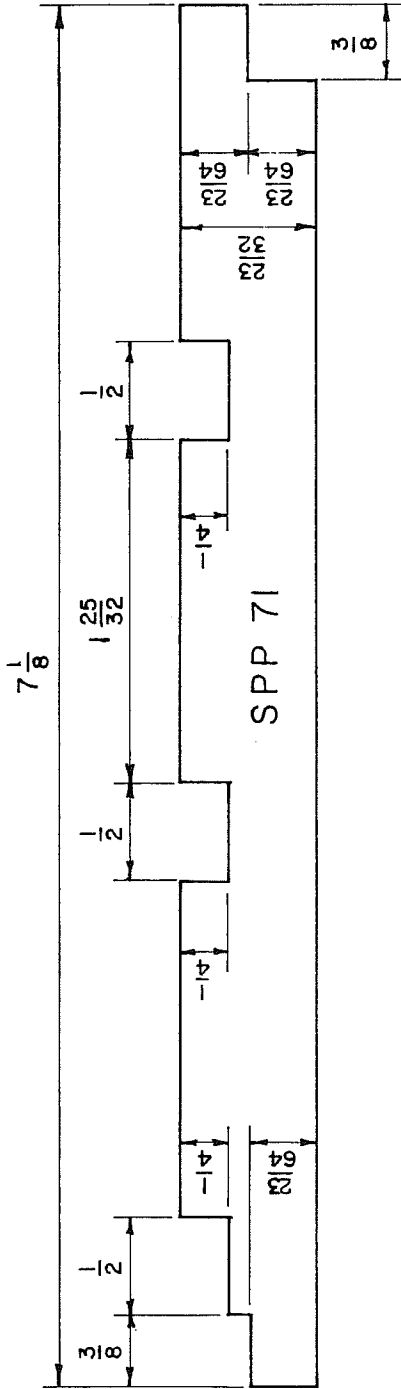
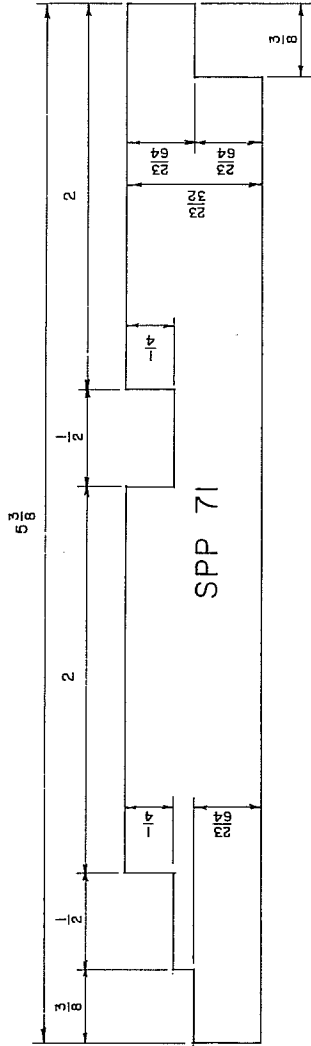

STANDARD PATTERNS OF DROP SIDING
 (Orders should specify pattern numbers.)

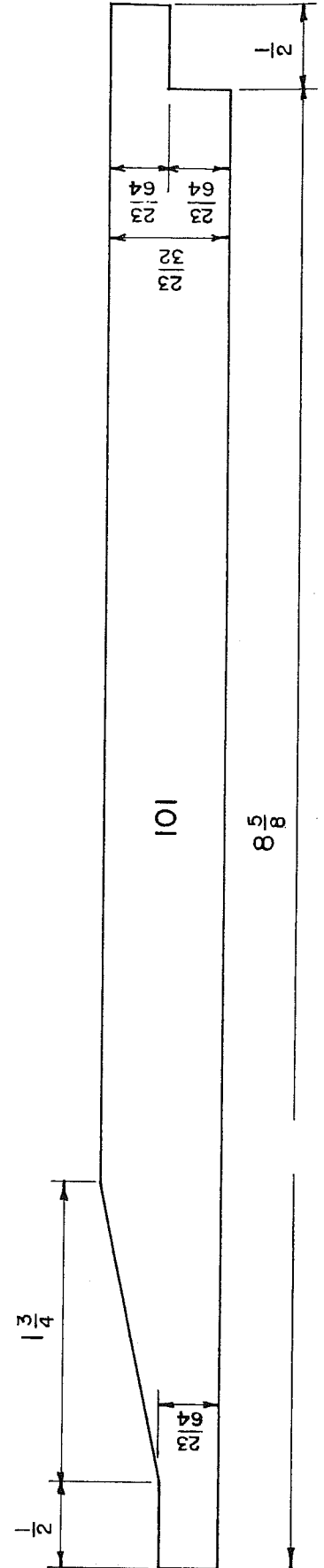
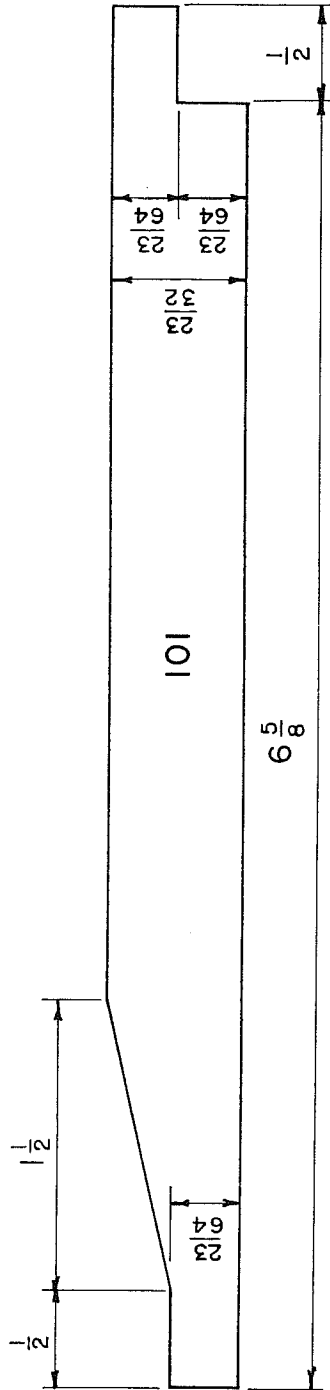
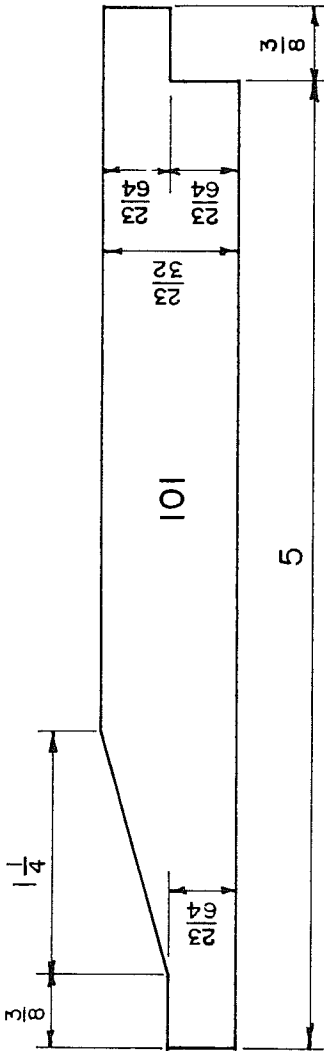

STANDARD PATTERNS OF DROP SIDING—Continued
 (Orders should specify pattern numbers.)

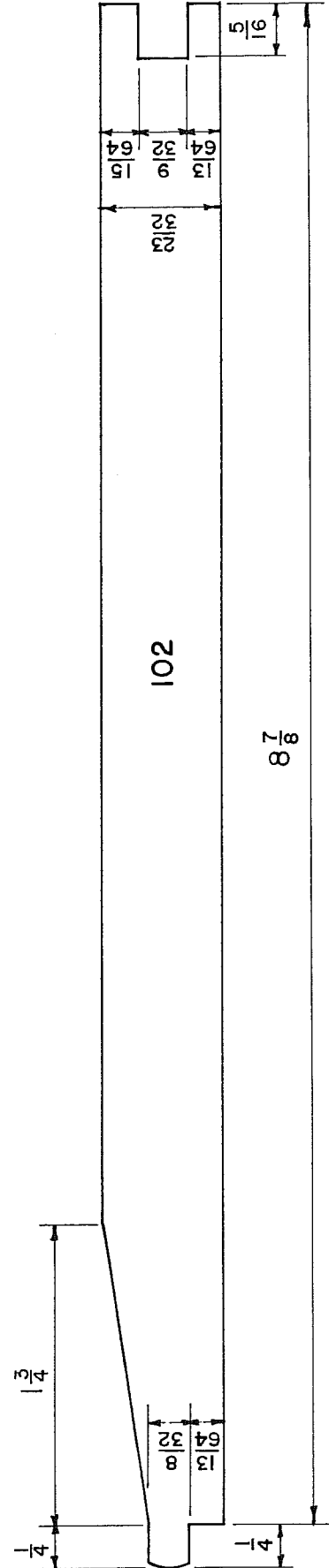
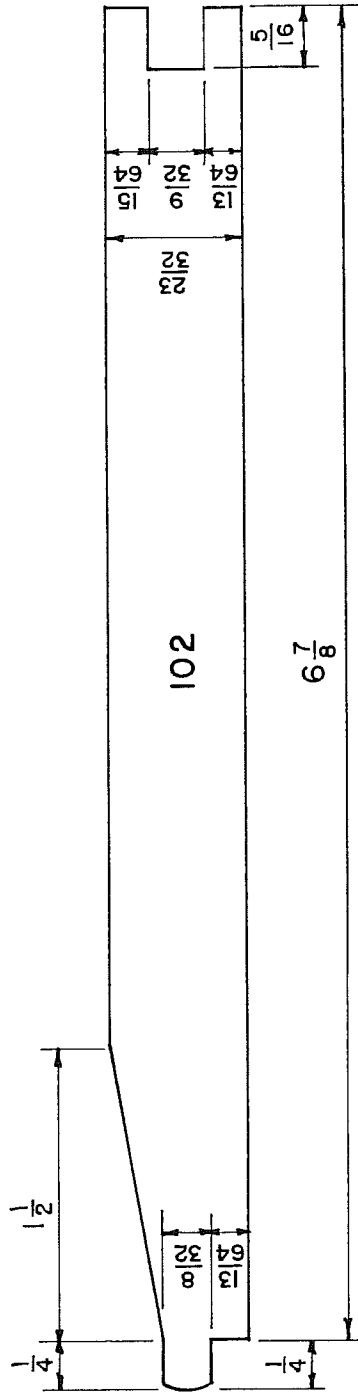
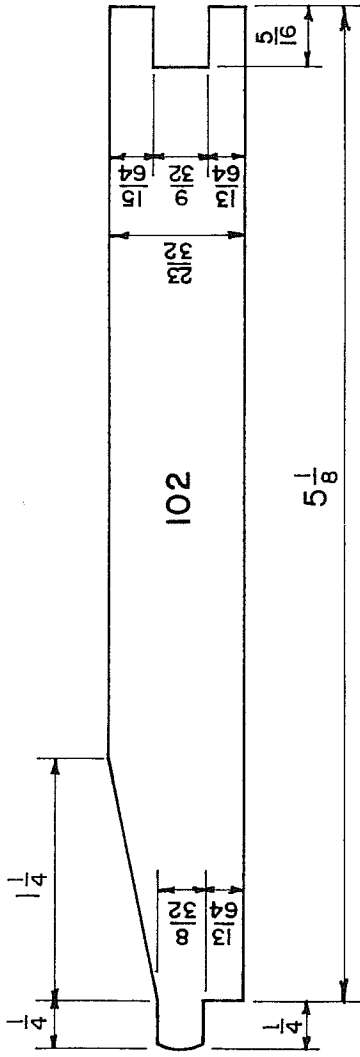

STANDARD PATTERNS OF DROP SIDING—Continued
 (Orders should specify pattern numbers.)

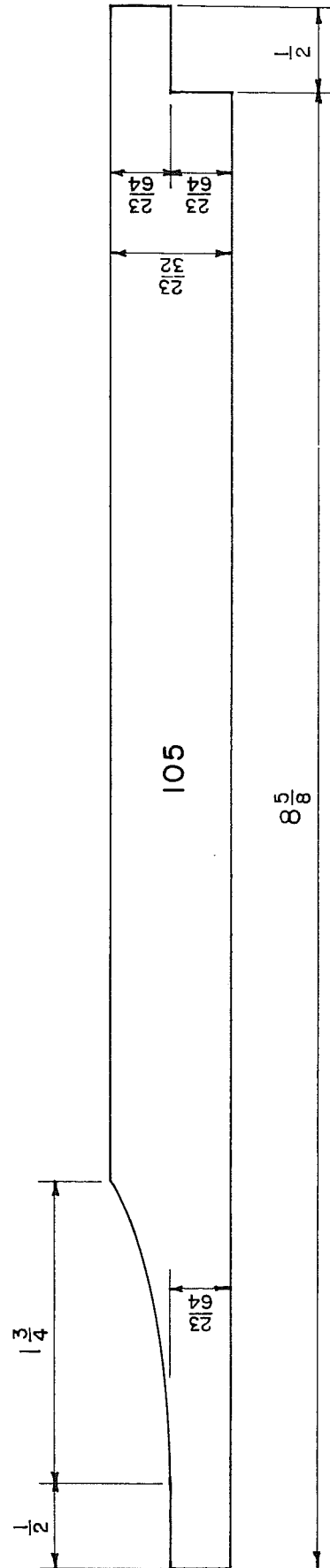
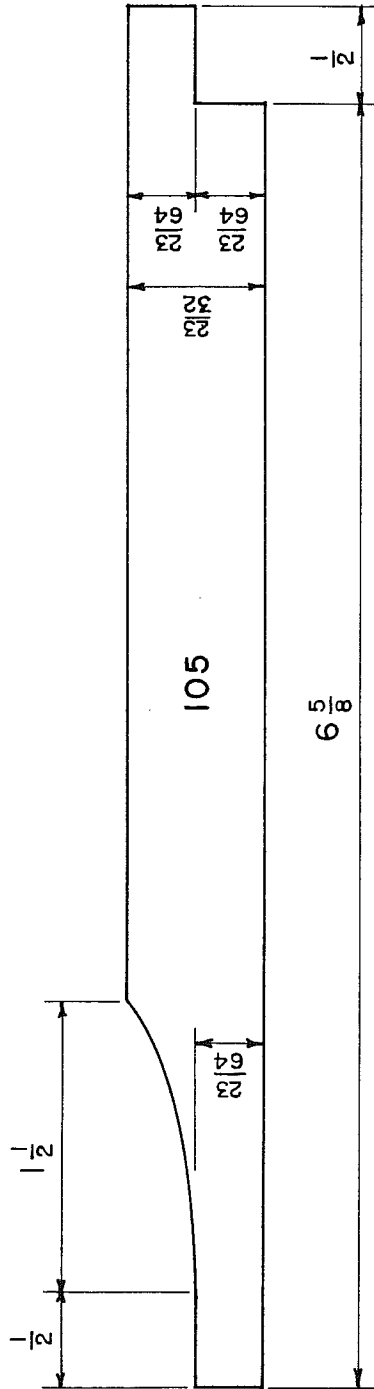
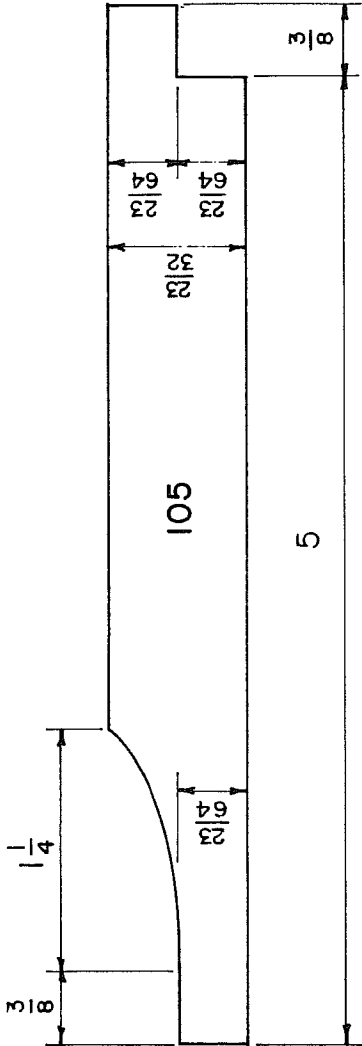

STANDARD PATTERNS OF DROP SIDING—Continued
 (Orders should specify pattern numbers.)

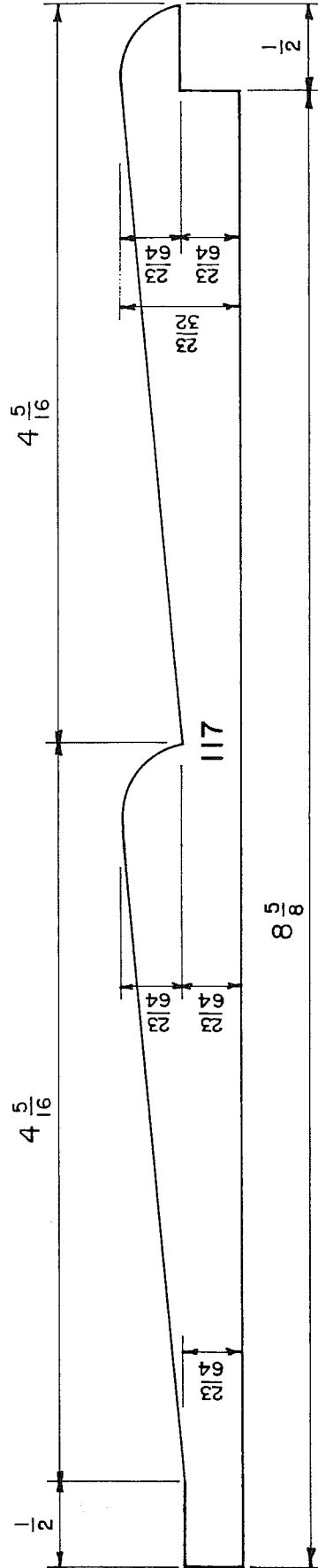
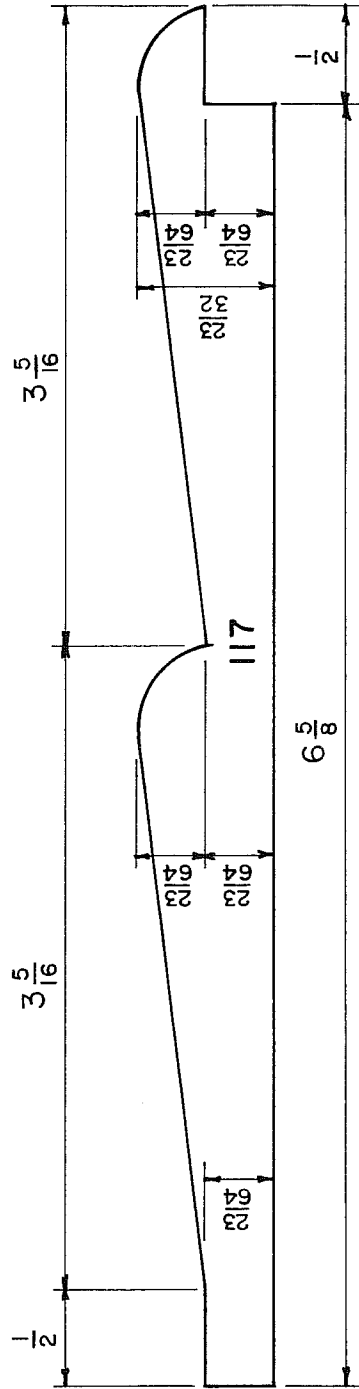
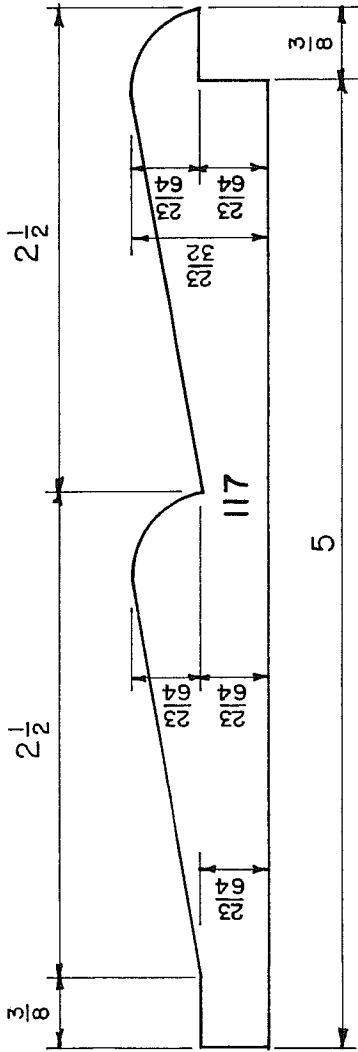

STANDARD PATTERNS OF DROP SIDING—Continued
 (Orders should specify pattern numbers.)

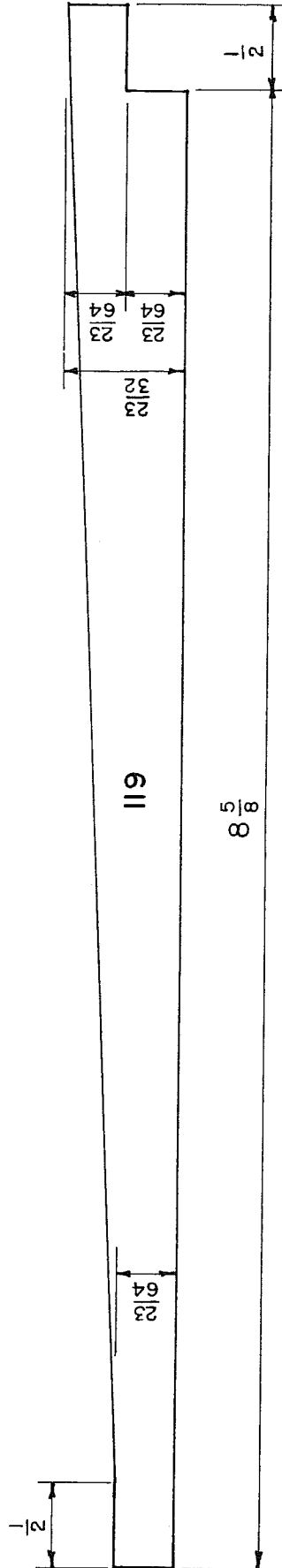
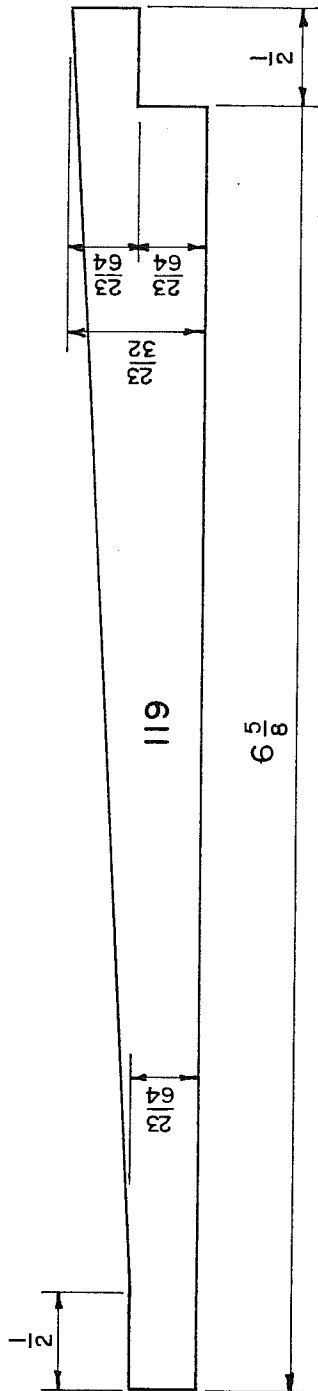
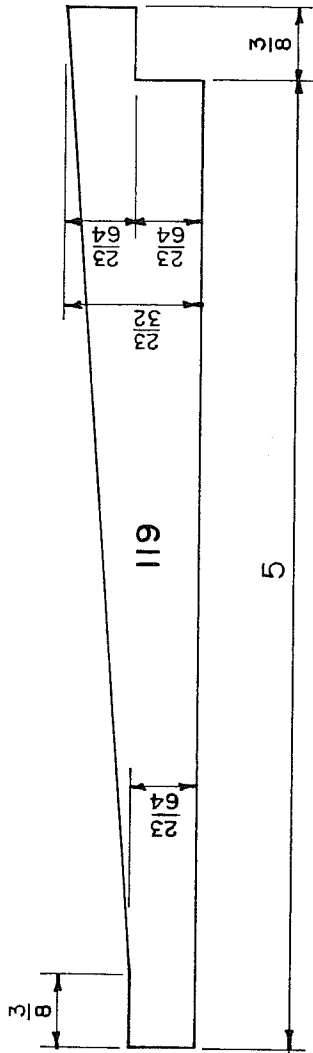

STANDARD PATTERNS OF DROP SIDING—Continued
 (Orders should specify pattern numbers.)

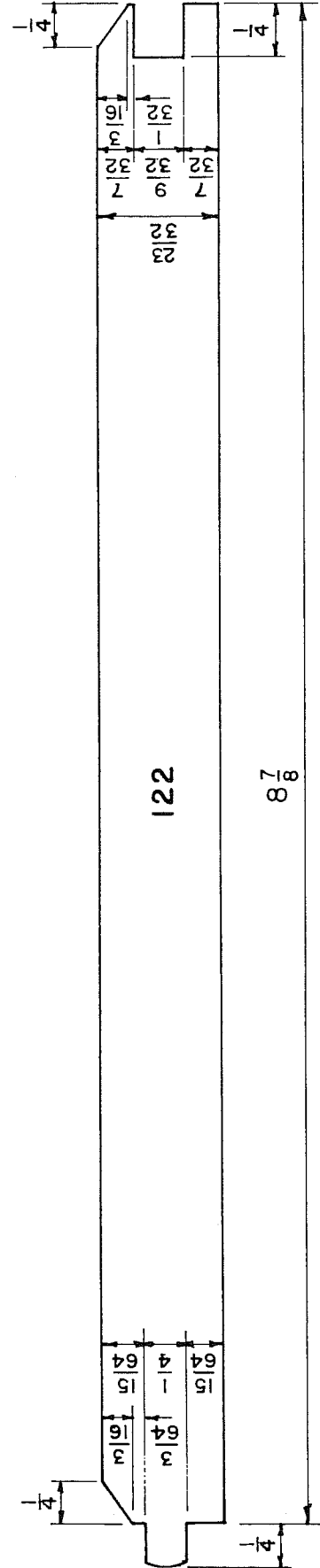
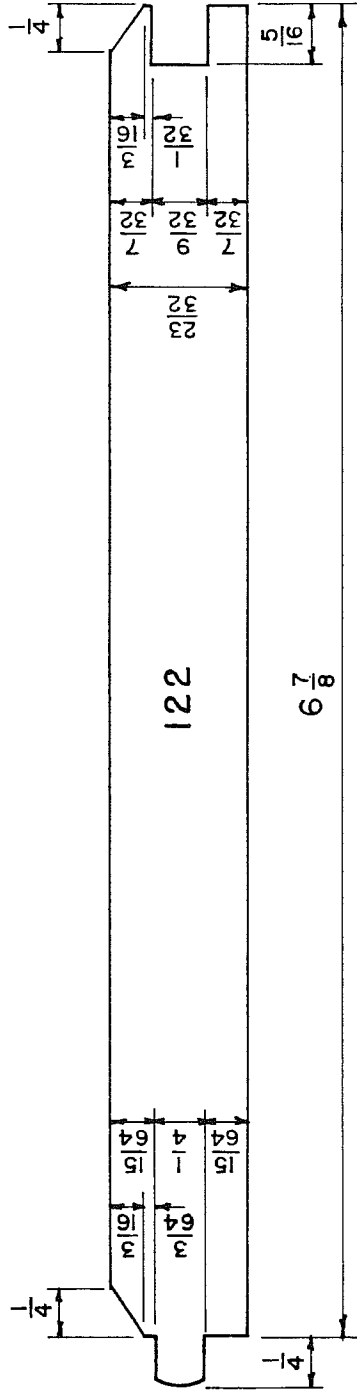
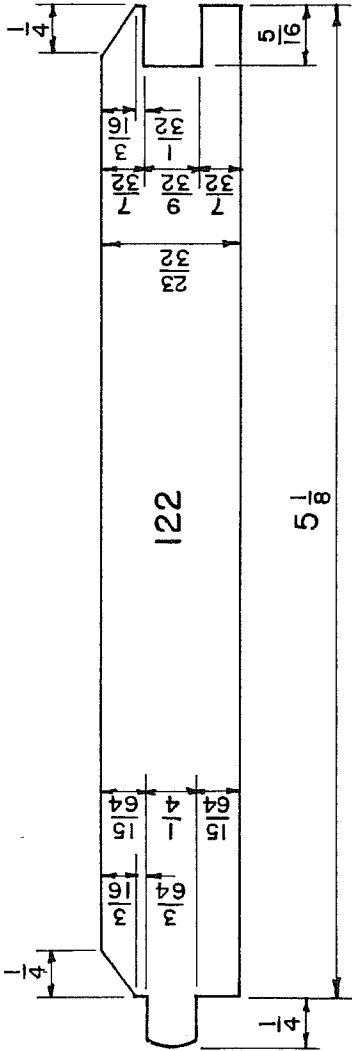

STANDARD PATTERNS OF DROP SIDING—Continued
 (Orders should specify pattern numbers.)

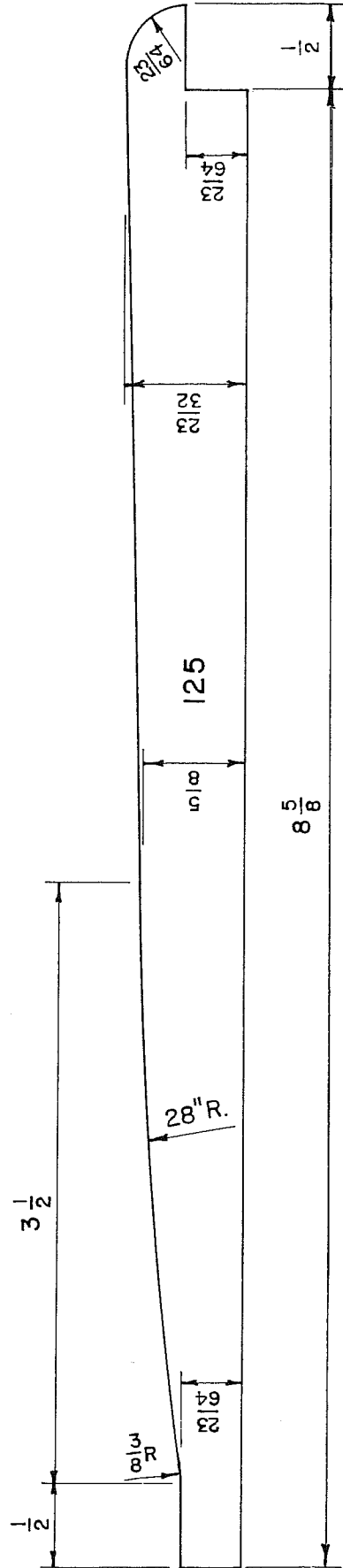
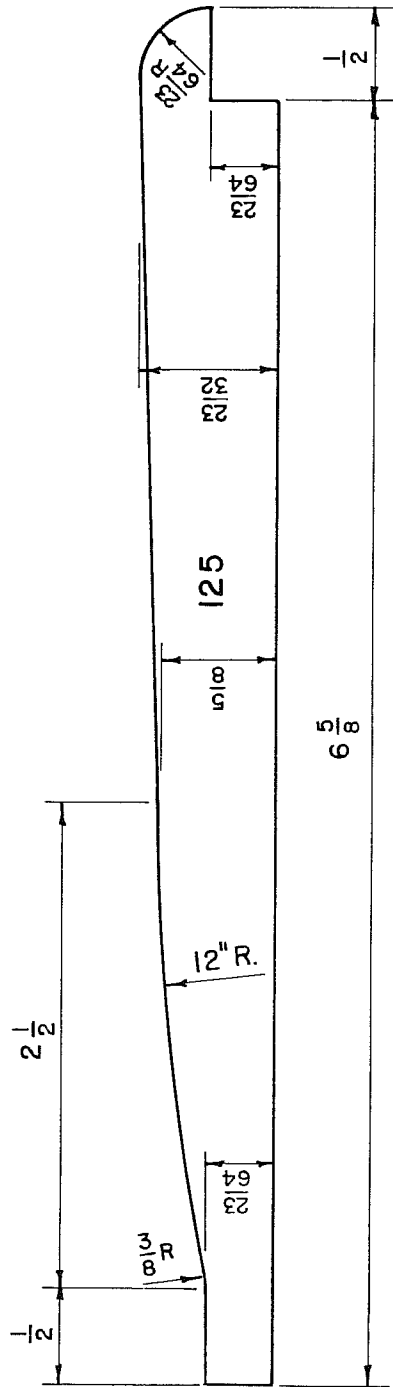
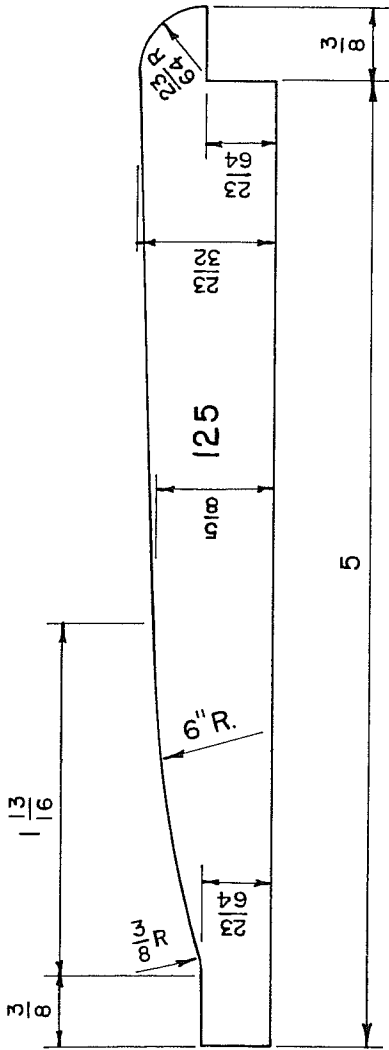

STANDARD PATTERNS OF DROP SIDING—Continued
 (Orders should specify pattern numbers.)

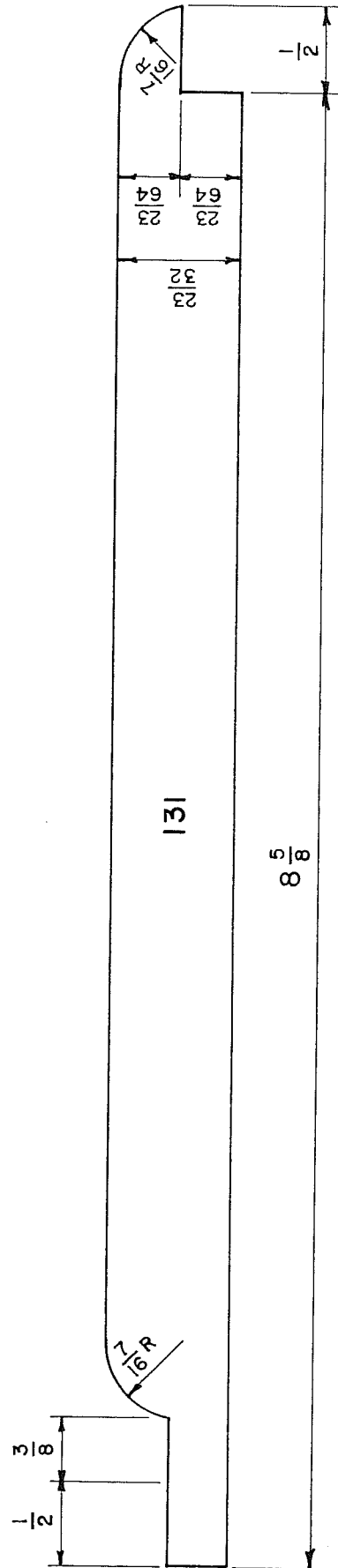
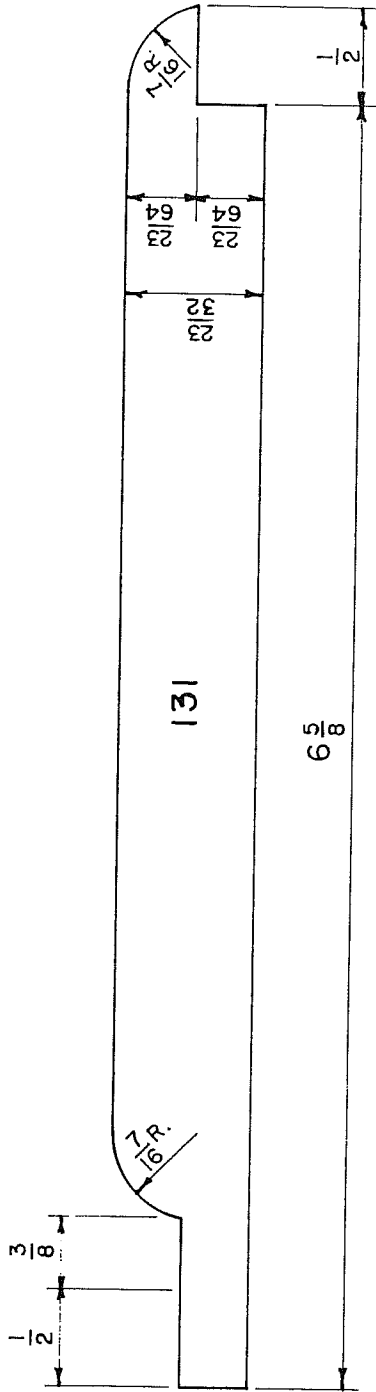
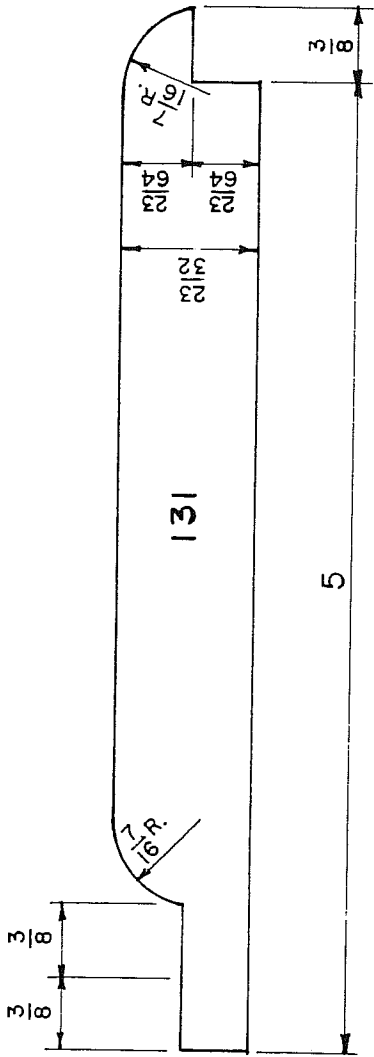

STANDARD PATTERNS OF DROP SIDING—Continued
 (Orders should specify pattern numbers.)

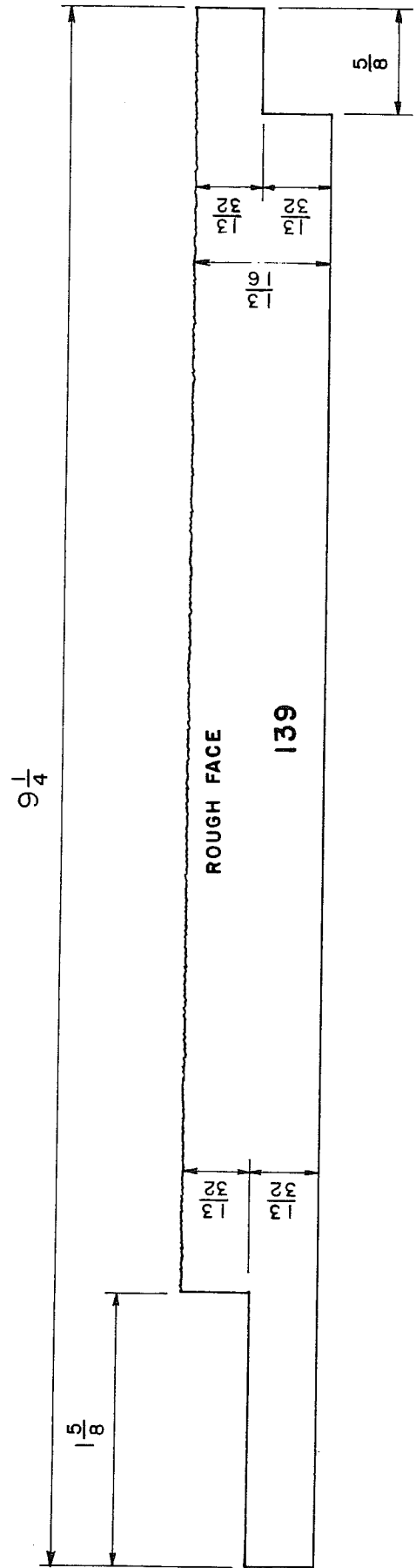
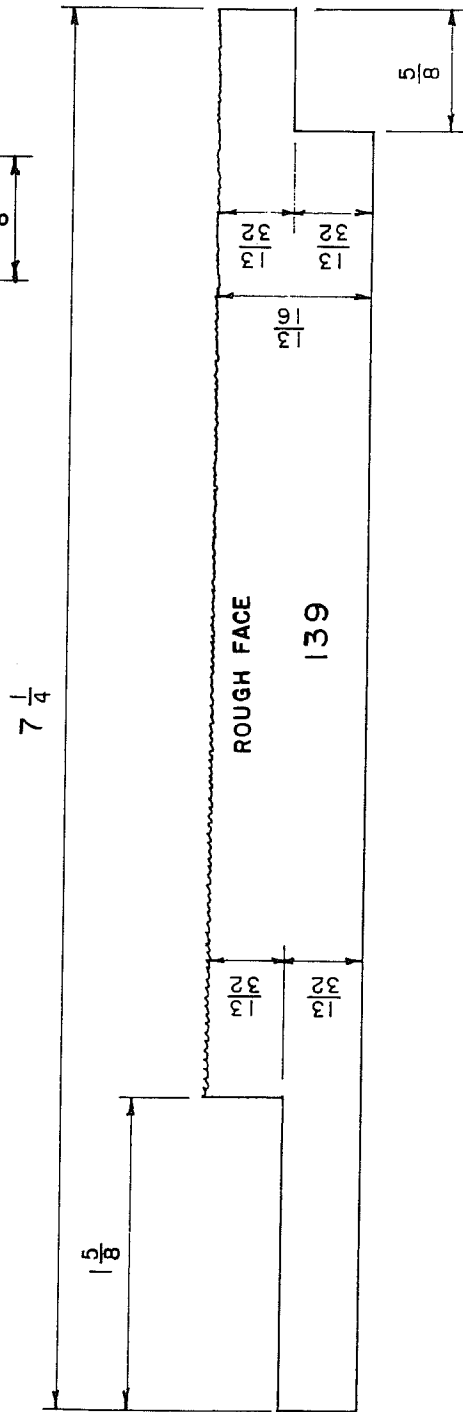
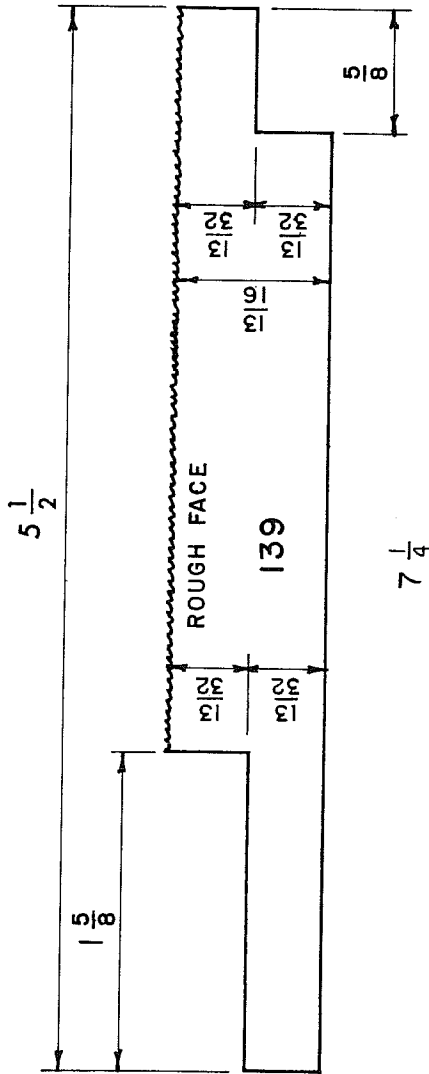

STANDARD PATTERNS OF DROP SIDING—Continued
 (Orders should specify pattern numbers.)

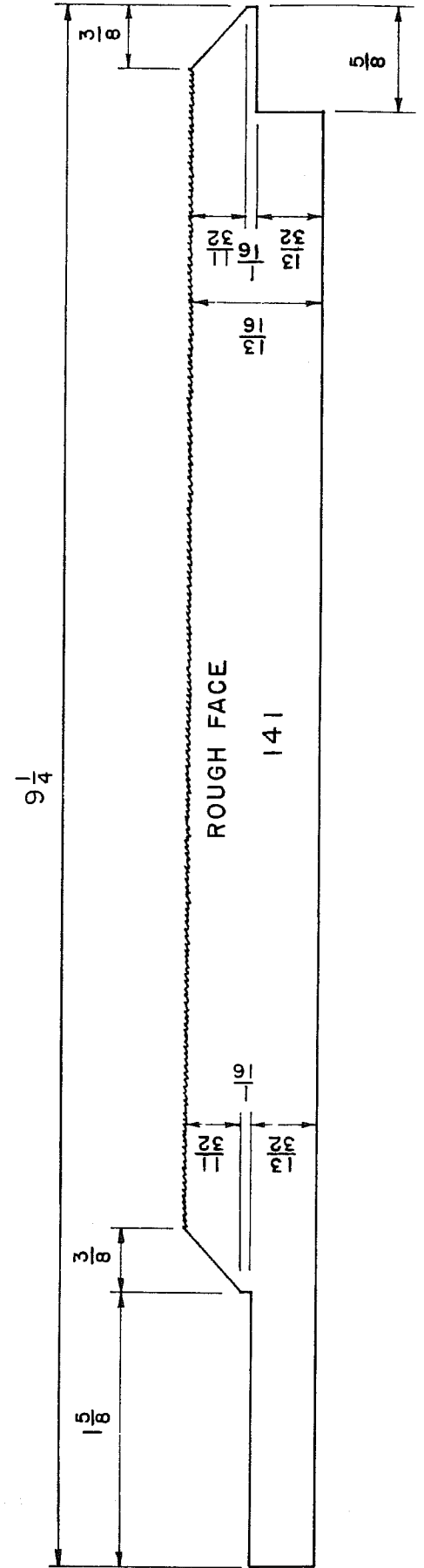
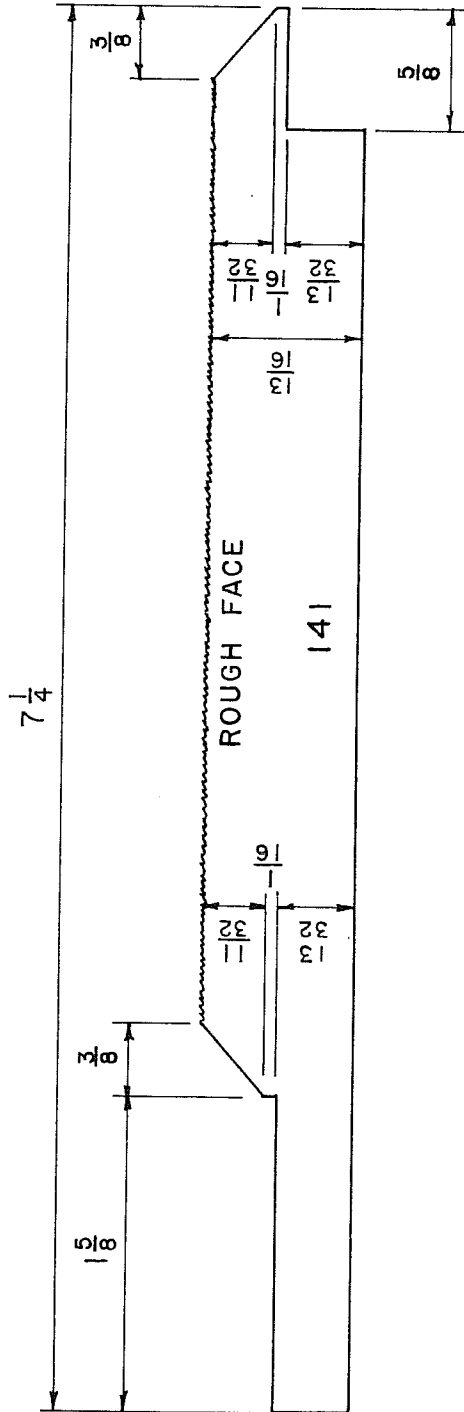
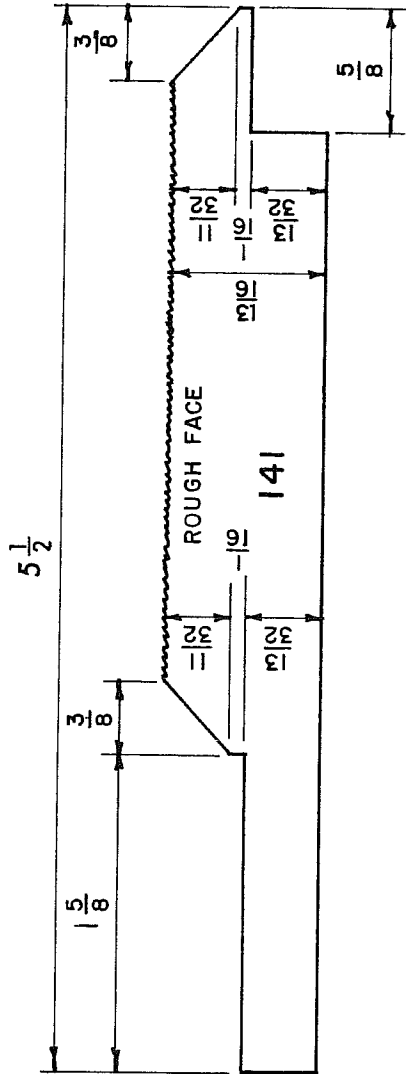

STANDARD PATTERNS OF DROP SIDING—Continued
(Orders should specify pattern numbers.)

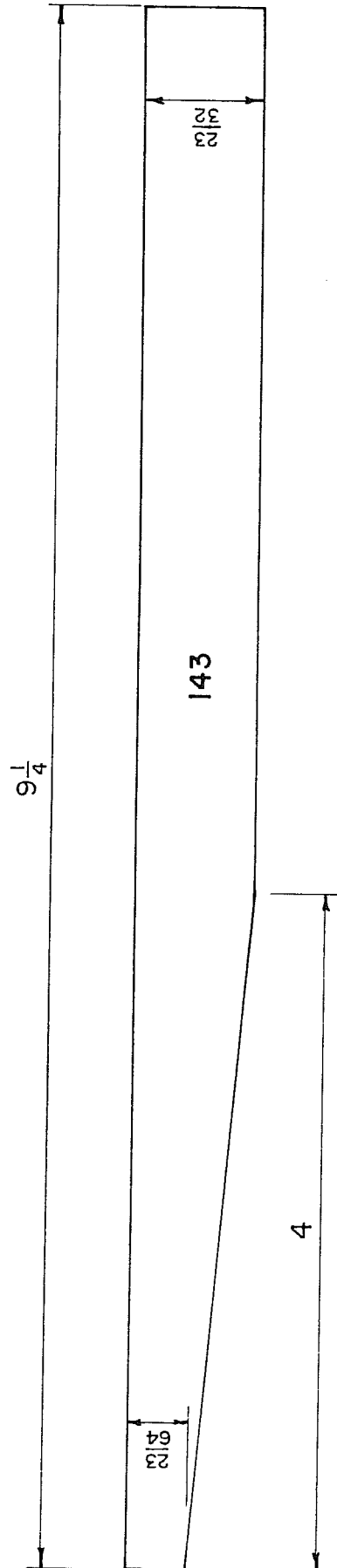
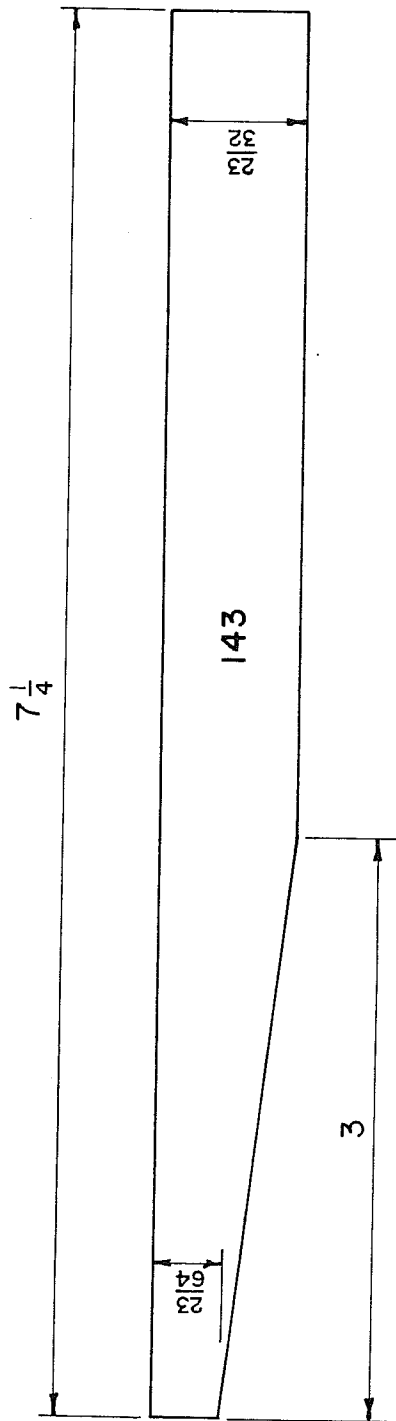

STANDARD PATTERNS OF DROP SIDING—Continued
 (Orders should specify pattern numbers.)

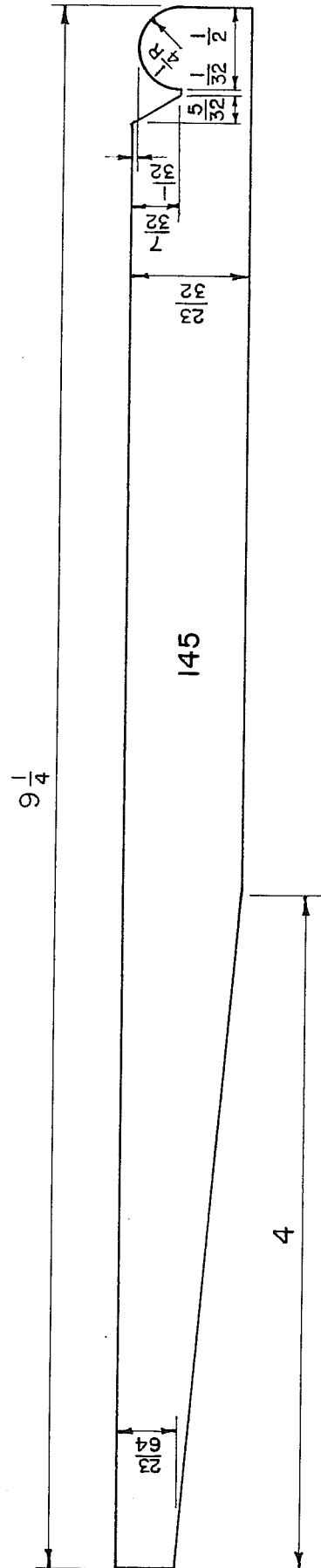
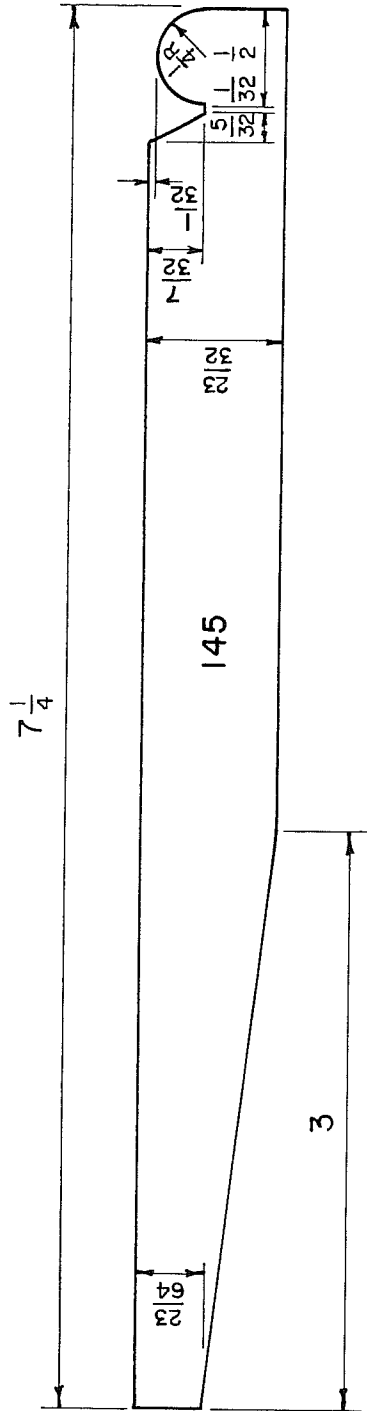

STANDARD PATTERN OF BEVEL SIDING

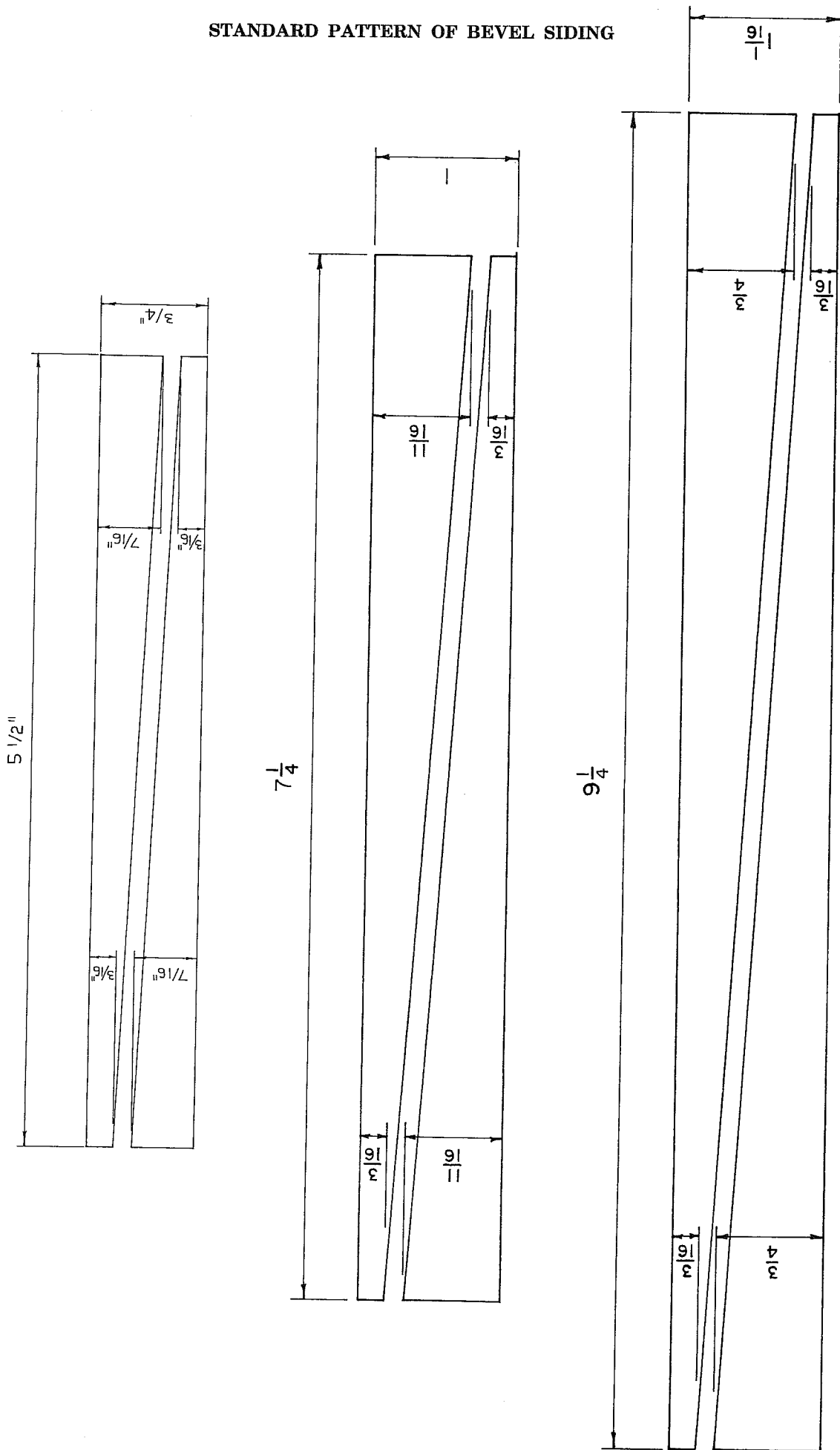

STANDARD PATTERN OF FLOORING

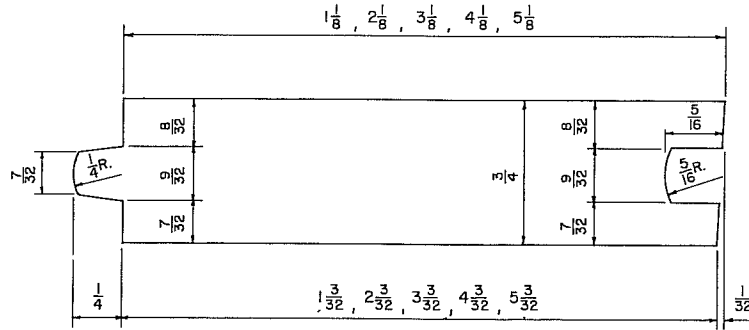

STANDARD 1" S2S&CM

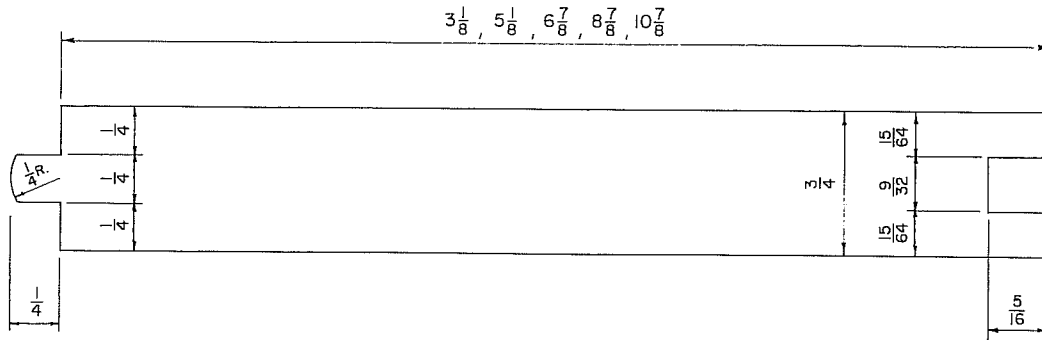

STANDARD 1" SHIPLAP

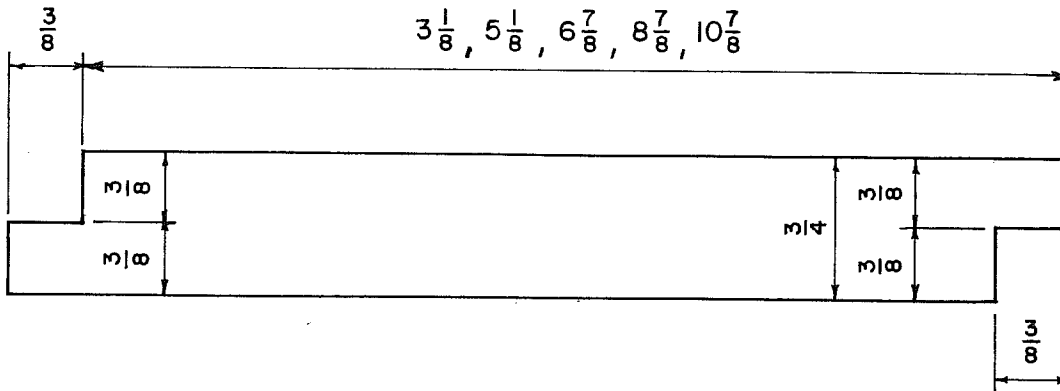

STANDARD BEAD AND V DETAILS

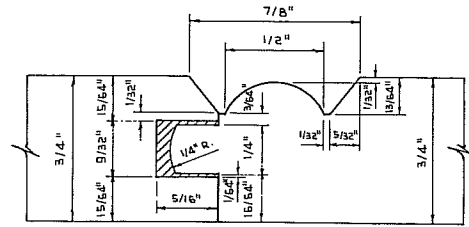

Barn Siding Bead (par. 260.6)

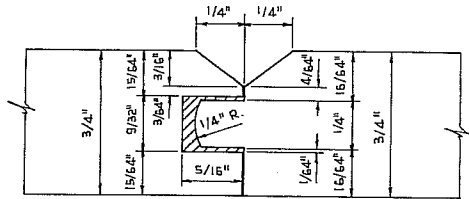

**S2S&CM-EV1S
(Same V if 2" or over)**

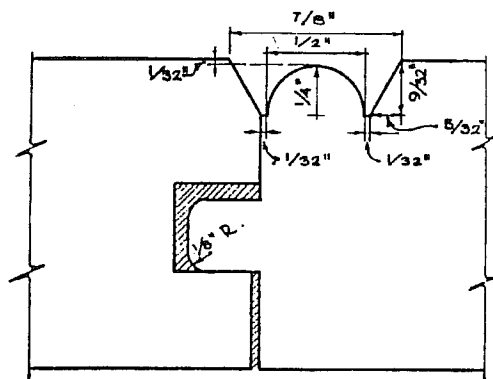

**EB1S for any of the following patterns
of S2S&CM and S2S&SM.**

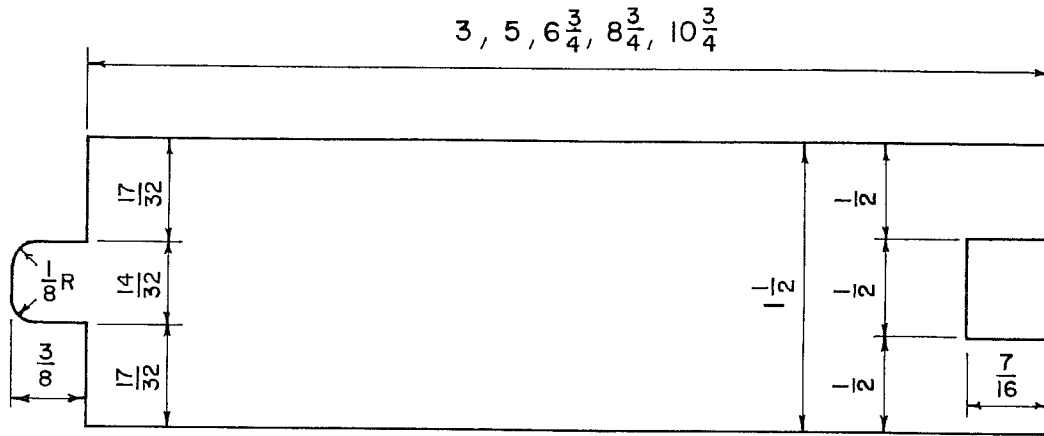

STANDARD 2" S2S&CM FLOORING OR DECKING
 (Same tongue and groove for 2 1/2".)

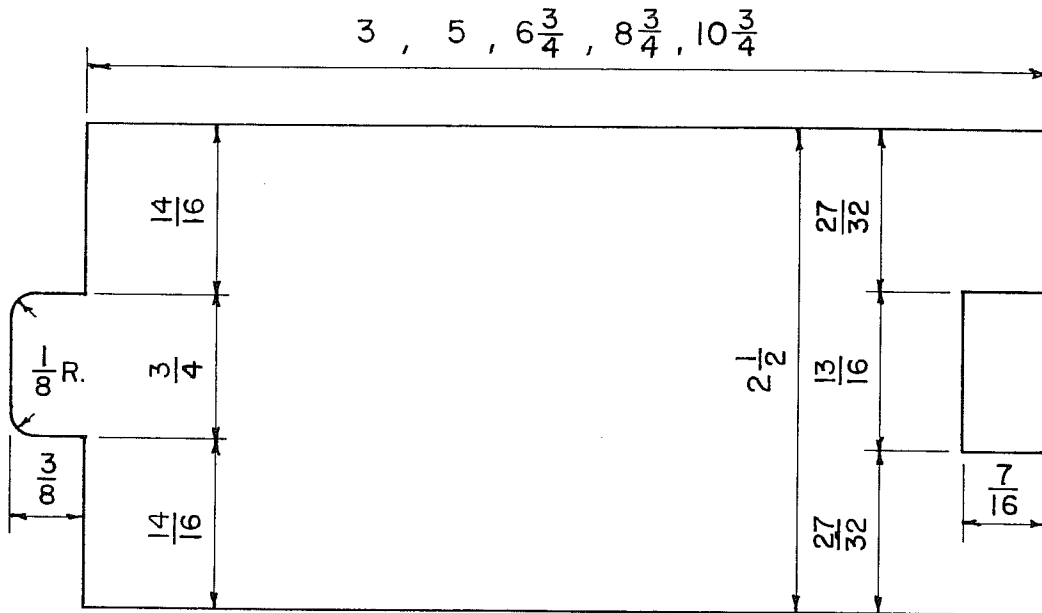

STANDARD 3" S2S&CM FLOORING OR DECKING

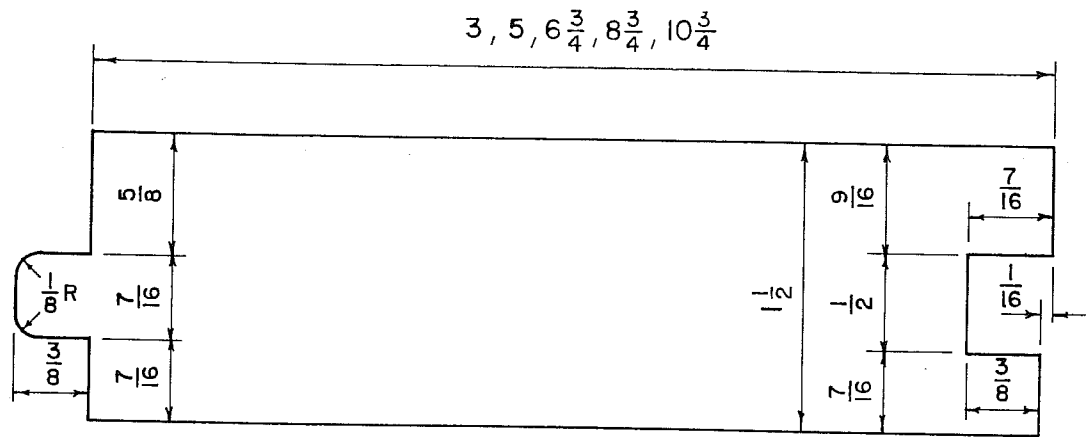

STANDARD 2" S2S&SM FLOORING OR DECKING

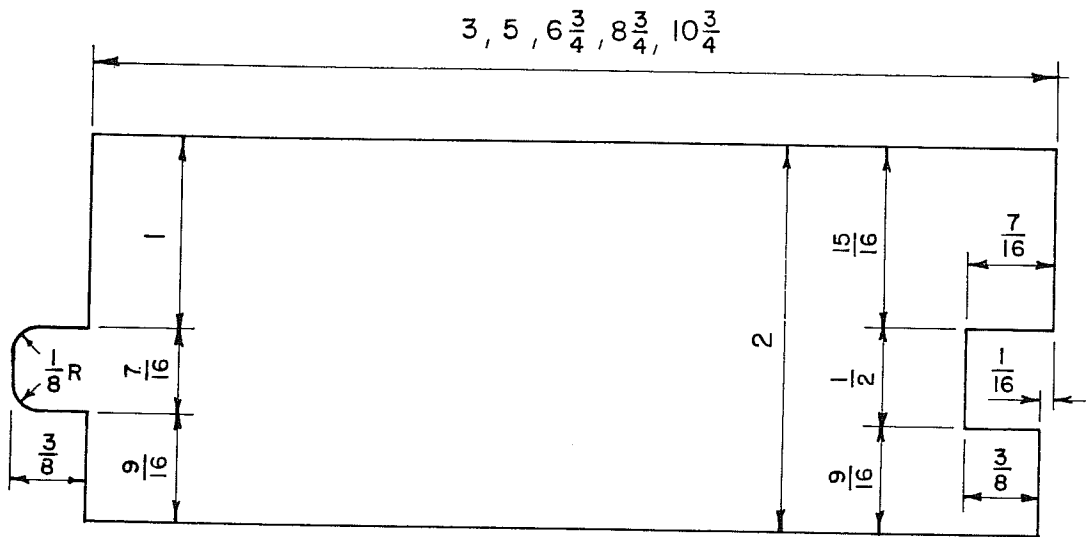

STANDARD 2 1/2" S2S&SM FLOORING OR DECKING

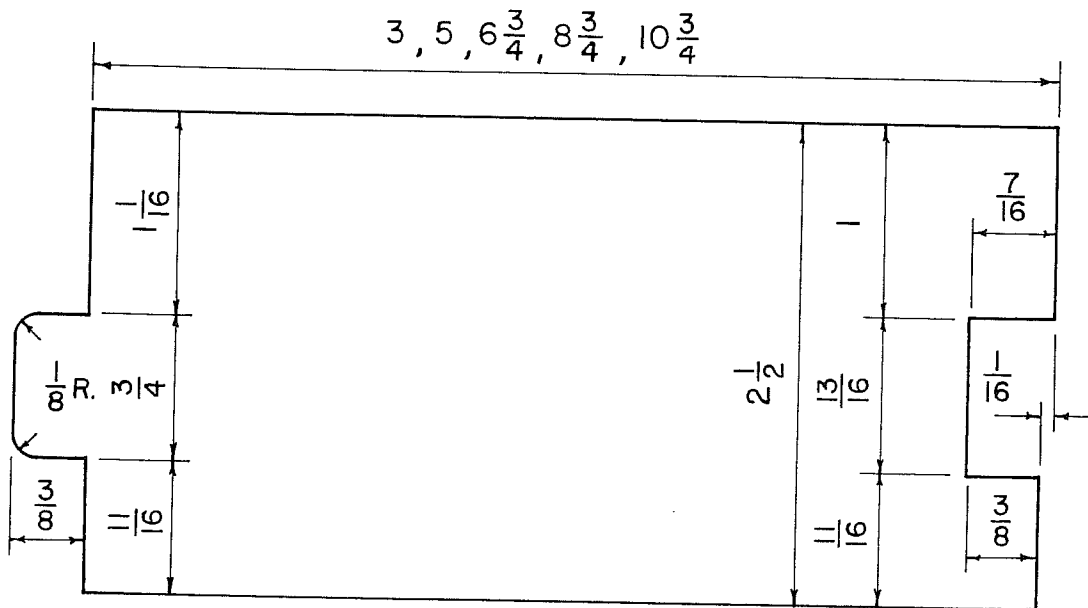

STANDARD 3" S2S&SM FLOORING OR DECKING

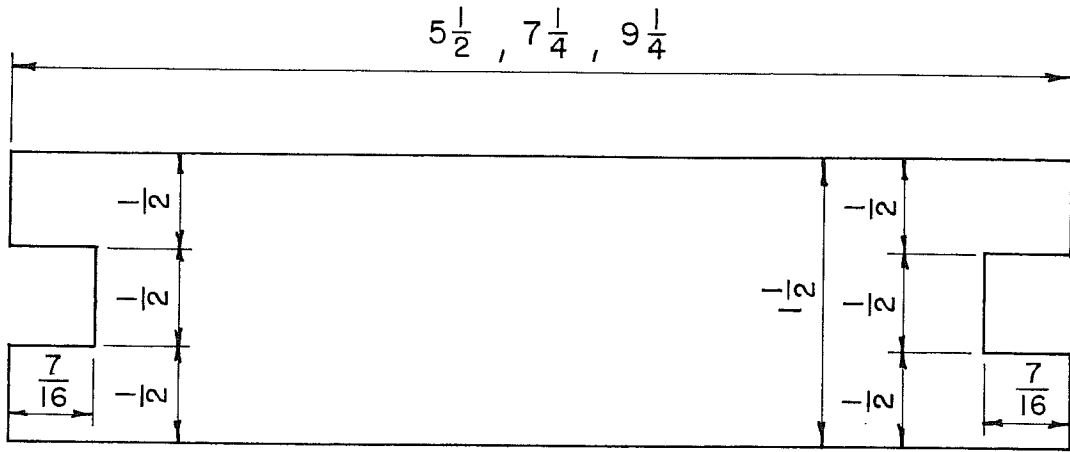

STANDARD 2" S2S&CG2E (GROOVED FOR SPLINES)

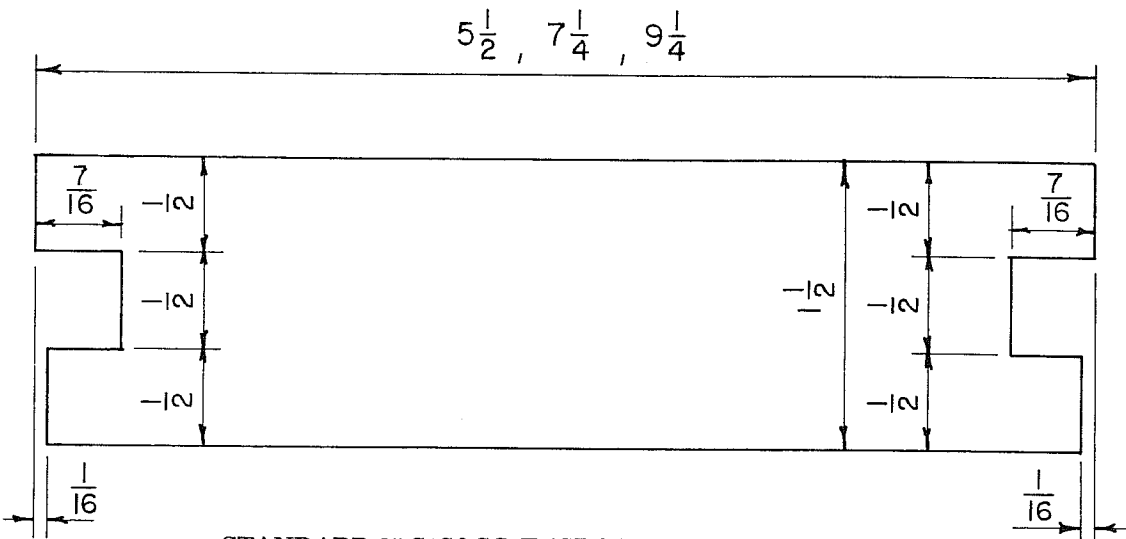

STANDARD 2" S1S&CG2E (GROOVED FOR SPLINES)

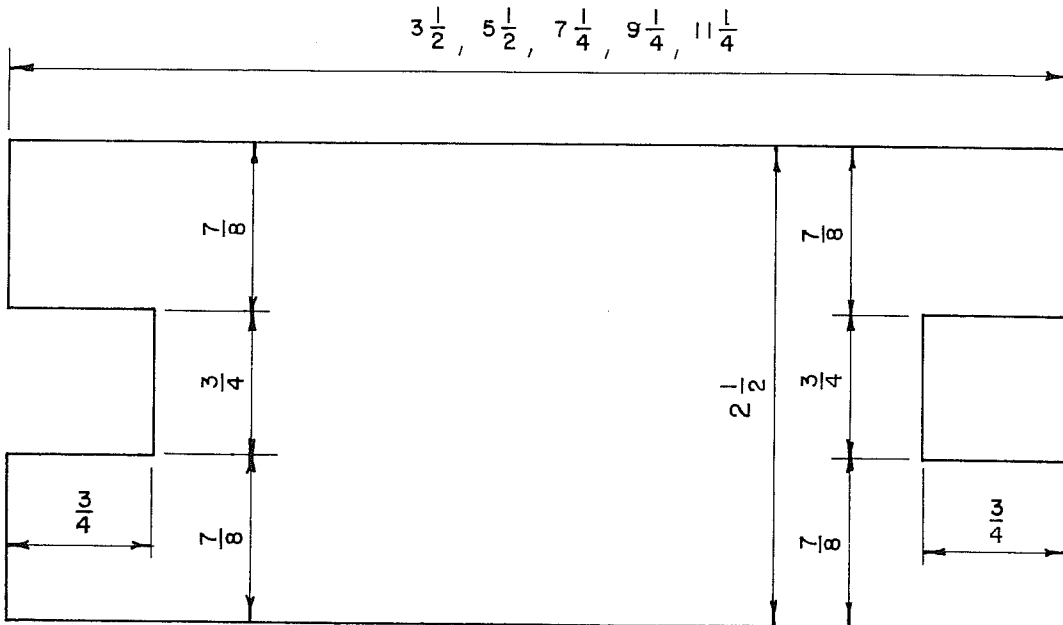

STANDARD 3" S2S&CG2E (GROOVED FOR SPLINES)

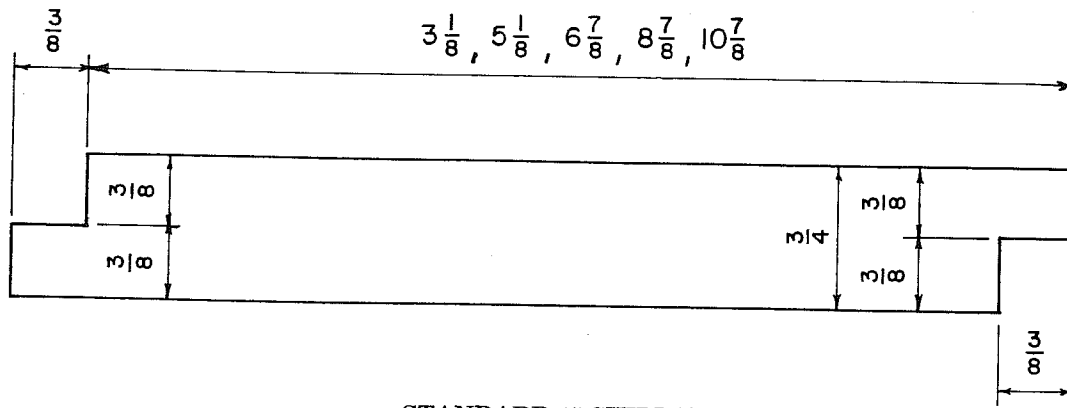

STANDARD 1" SHIPLAP

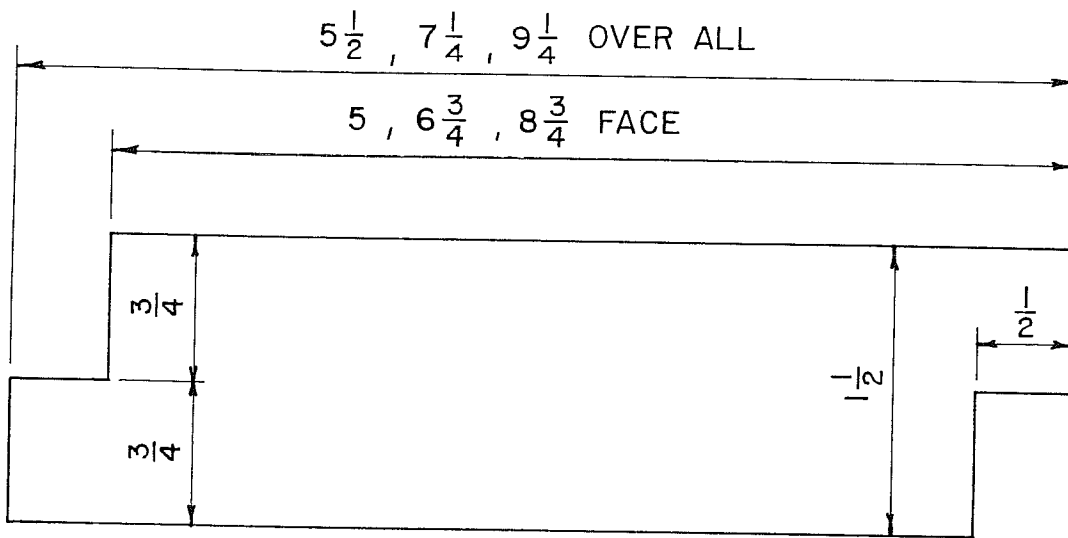

STANDARD 2" S2S&SL (HEAVY SHIPLAP)

SPECIAL DECKING

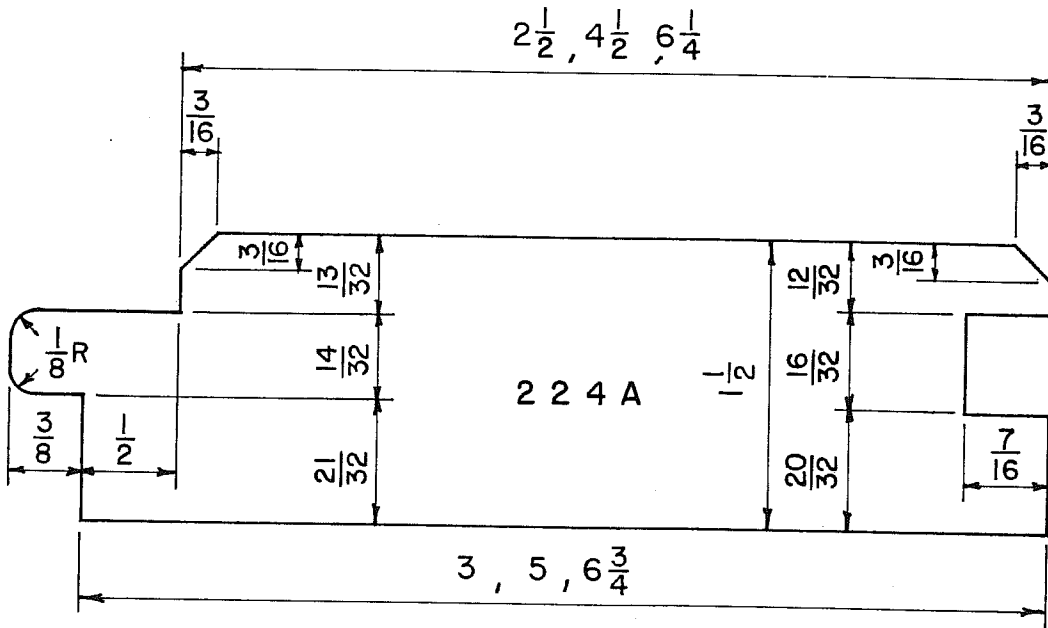
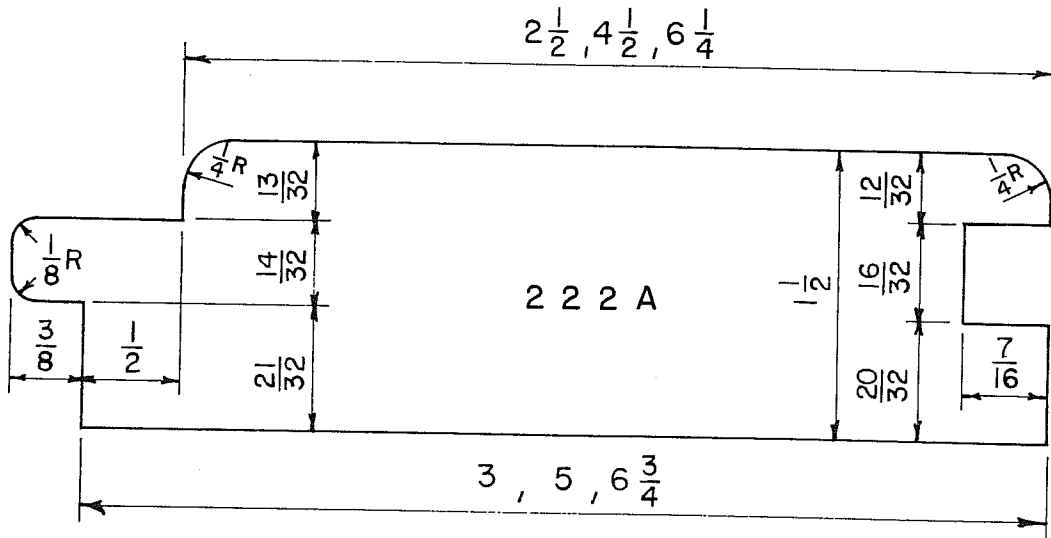
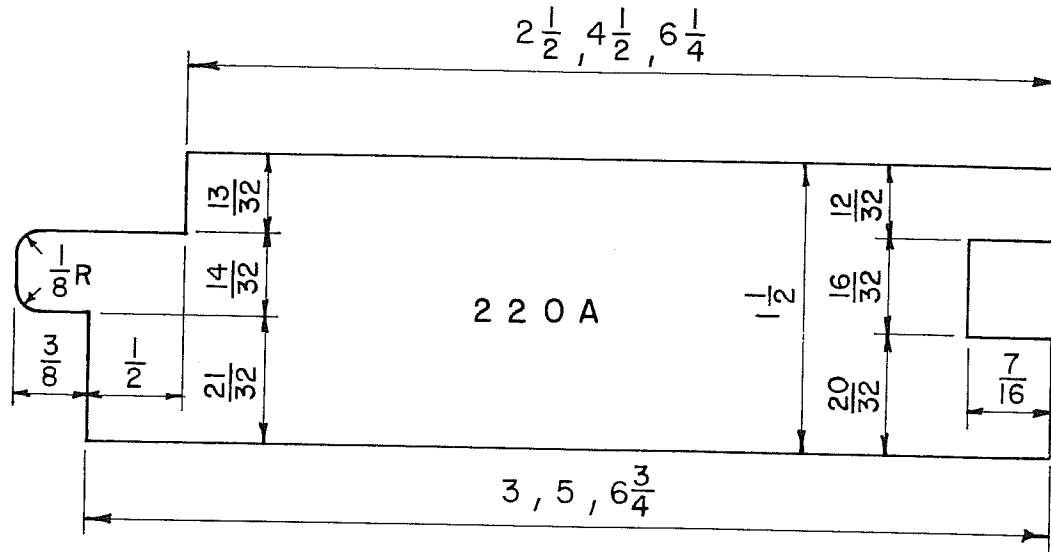

STANDARD PATTERNS OF CEILING

3/8x4
DB Ceiling

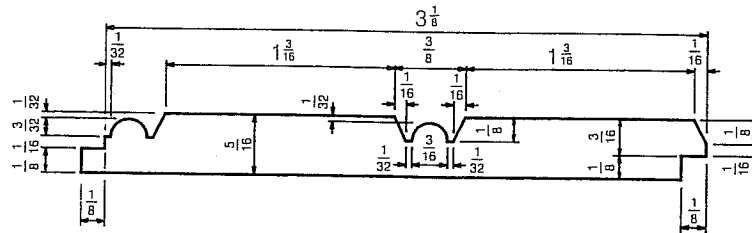

3/8x4
V Ceiling

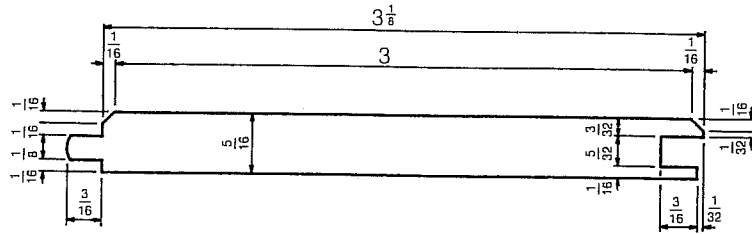

1/2x4
DB Ceiling

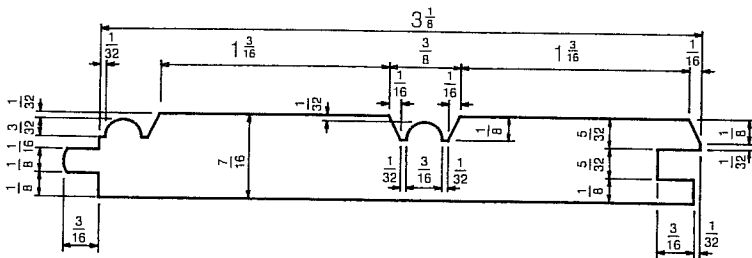

1/2x4
V Ceiling

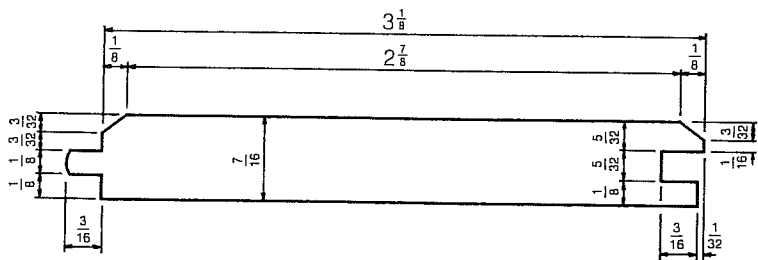

5/8x4
DB Ceiling

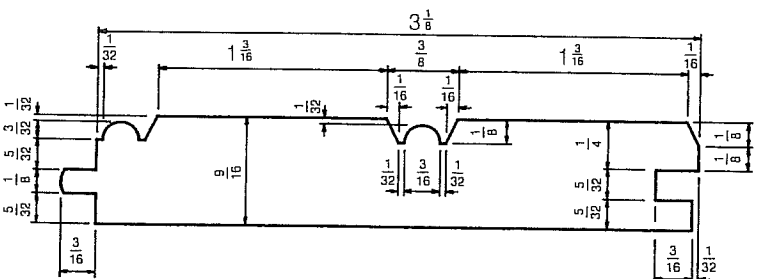

5/8x4
V Ceiling

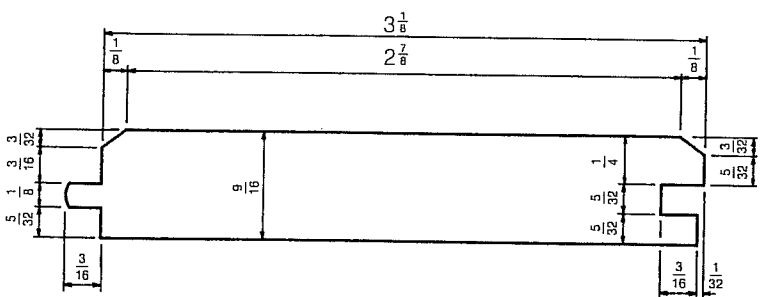

3/4x4
DB Ceiling

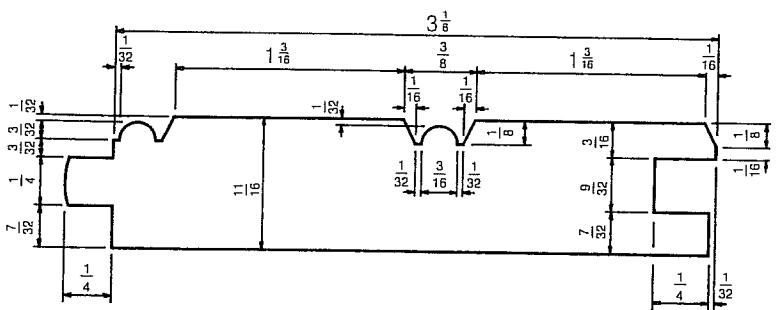

STANDARD PATTERN OF PARTITION

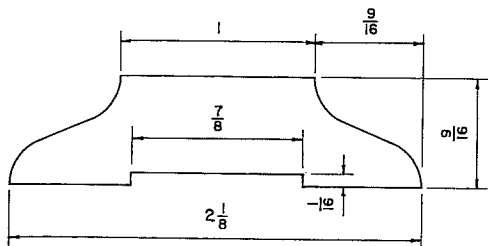
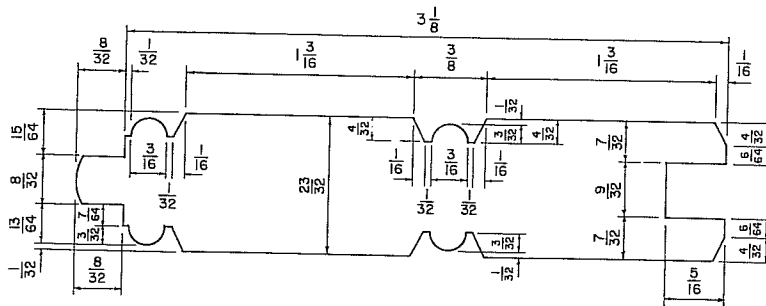

$\frac{5}{8} \times 3$ OG Batts

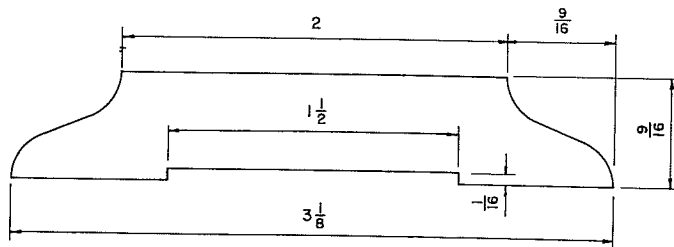

$\frac{5}{8} \times 4$ OG Batts

LOG CABIN SIDING (Graded under 2" Dimension Rules.)

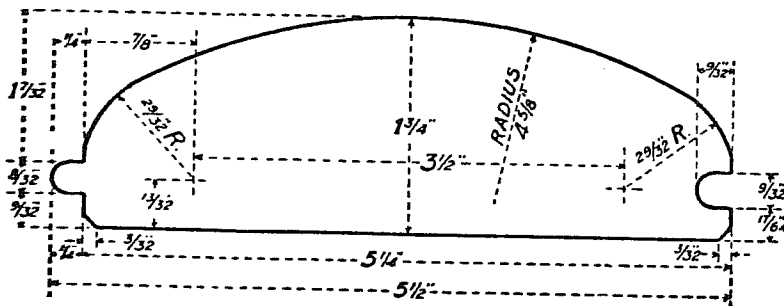
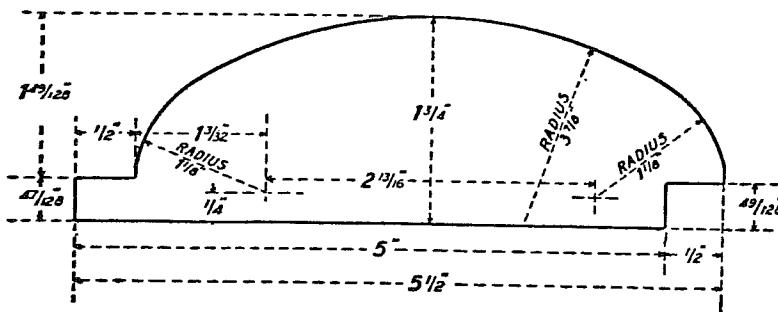

STANDARD PATTERNS OF DT&G ROOF DECKING

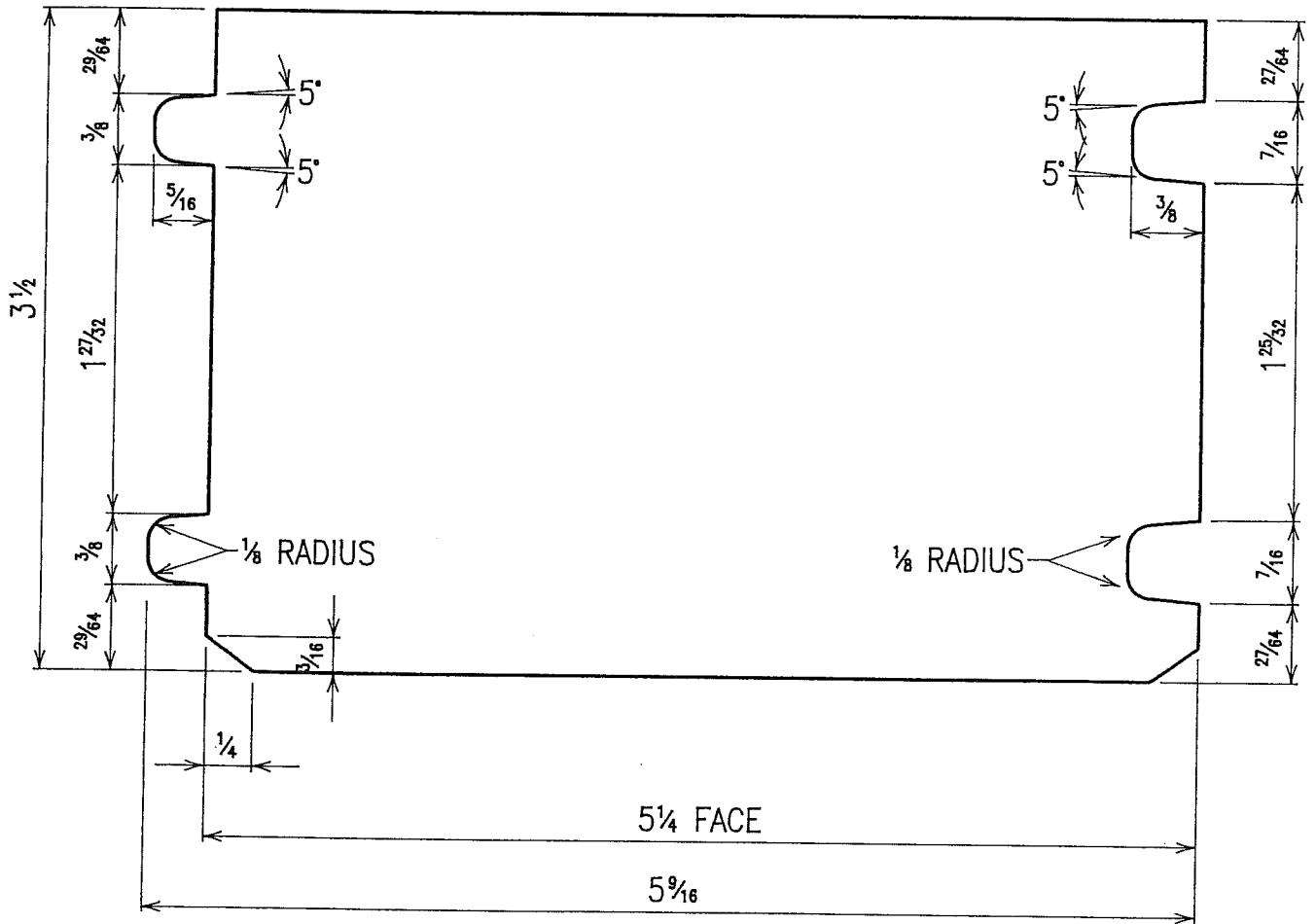
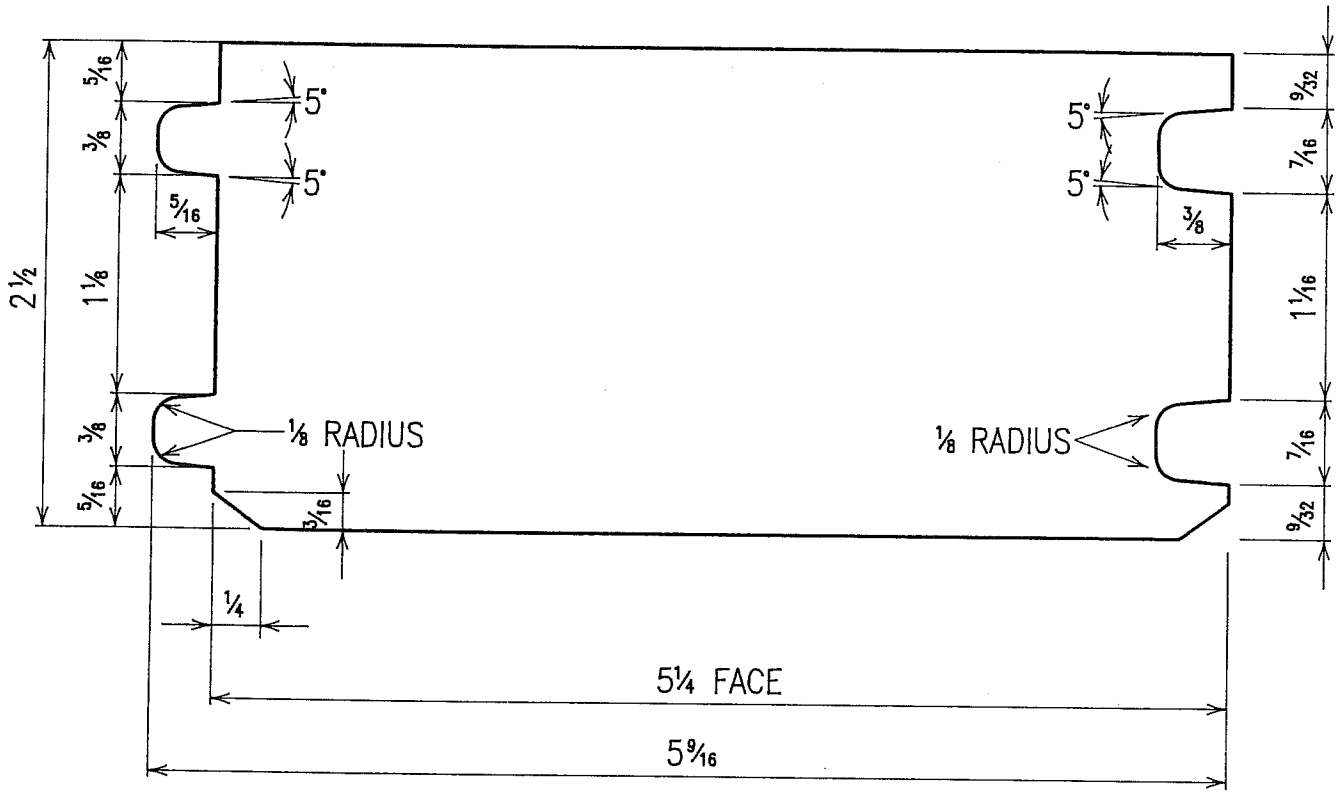

STANDARD PATTERNS OF DT&G ROOF DECKING

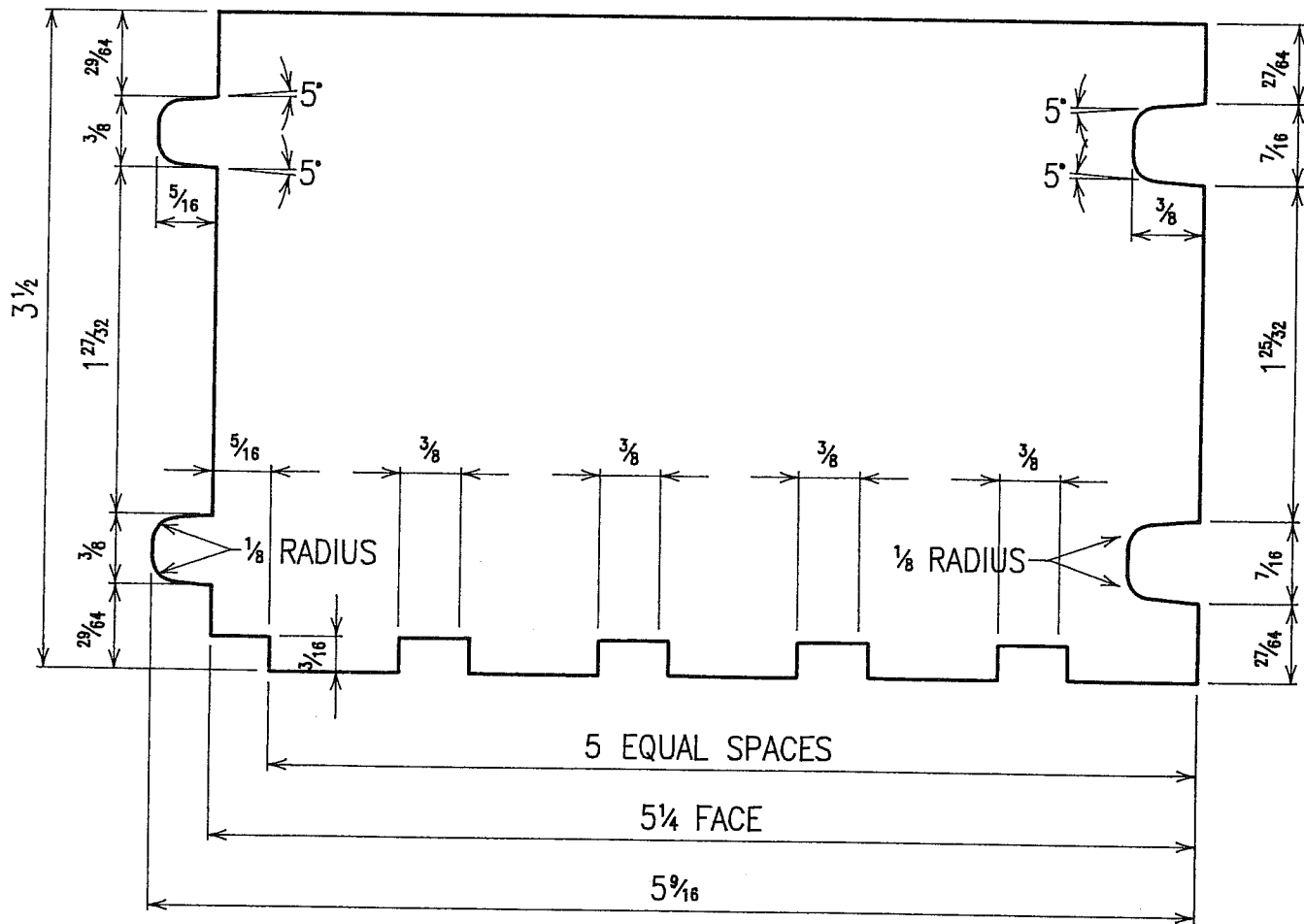
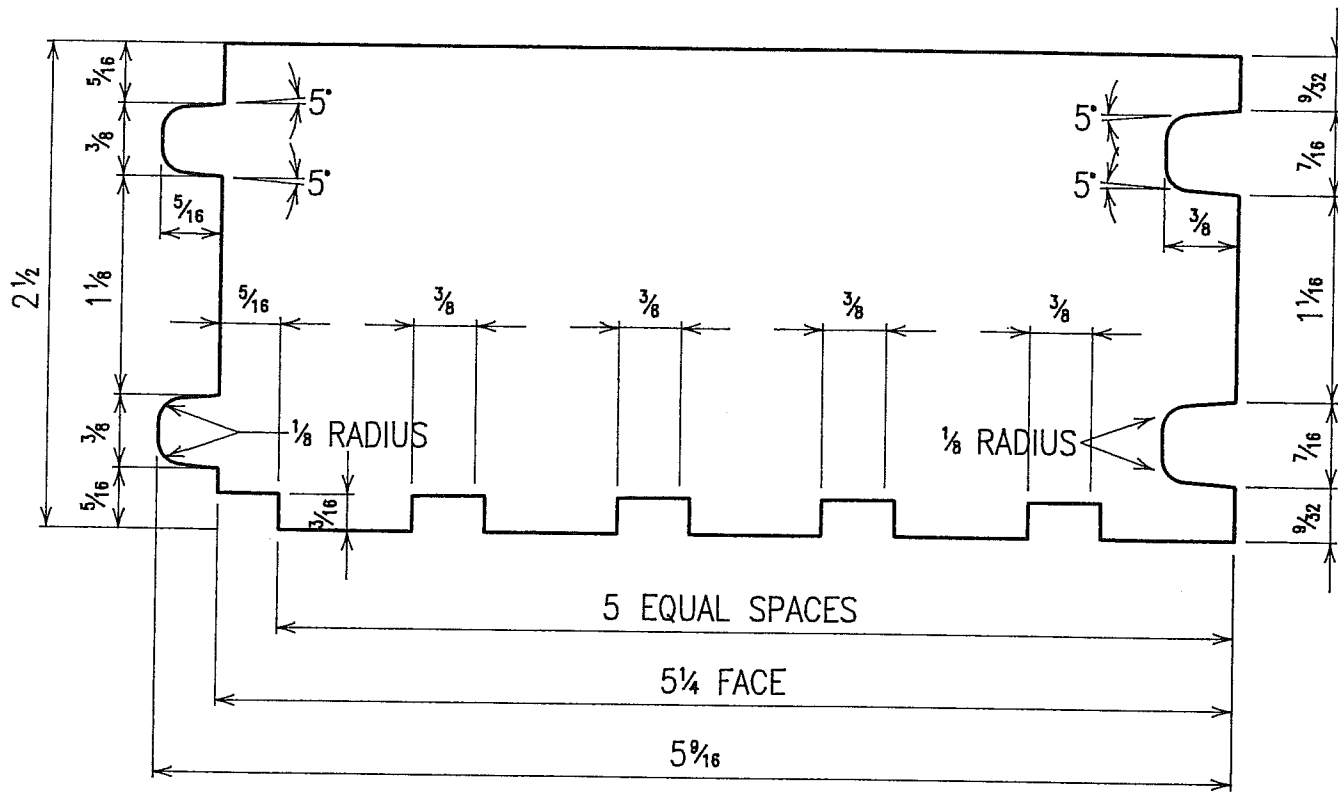

STANDARD PATTERNS OF DT&G ROOF DECKING

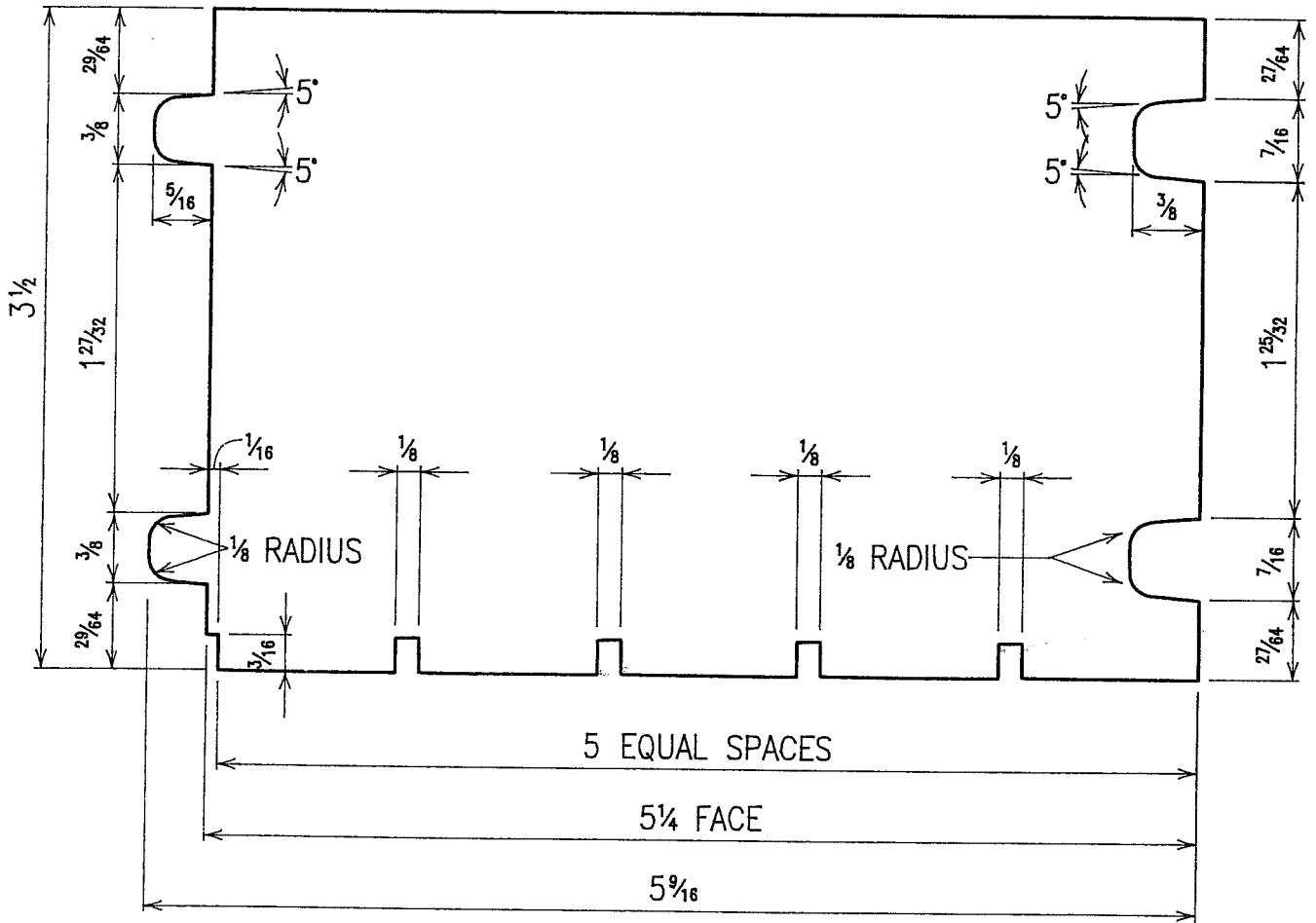
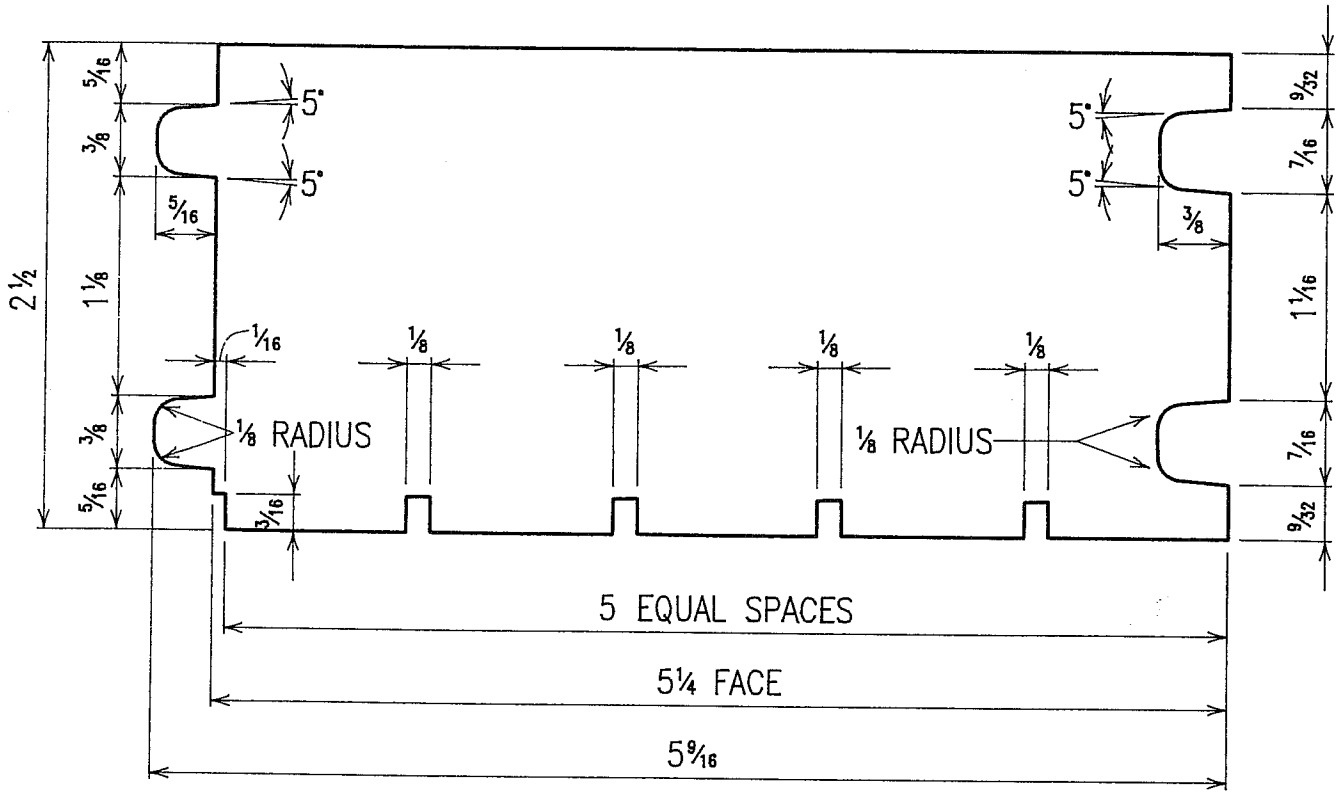

STANDARD PATTERNS OF DT&G ROOF DECKING

